

Track Supply 6 kW IP54

80 A / 125 A at 400 V / 480 V

Order Number

91008-111-3130927 (80 A, 400 V, RAL 7035 - light gray)

91012-111-3130928 (125 A, 400 V, RAL 7035 - light gray)

91008-111-3130929 (80 A, 480 V, RAL 7035 - light gray)

91012-111-3130930 (125 A, 480 V, RAL 7035 - light gray)

91000-111-3131371 (configurable version)

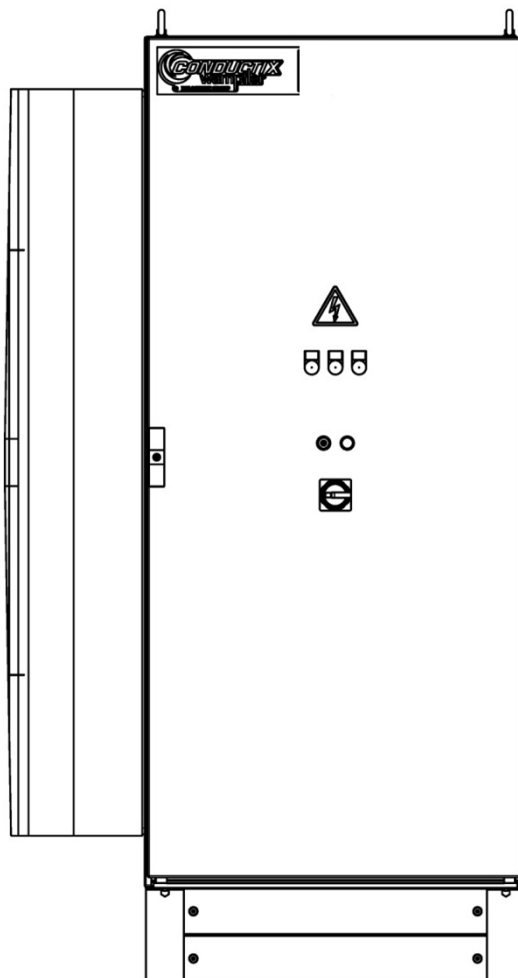

Figure shows conditioned variant



Track Supply 6 kW IP54

80 A / 125 A at 400 V / 480 V

Contents

	page
1 General Advice.....	6
1.1 Information About These Installation and Operating Instructions.....	6
1.2 Limitation of Liability.....	6
1.3 Copyright.....	7
1.4 Spare Parts.....	7
1.5 Material Defects.....	7
1.6 Technical Support.....	7
2 Safety Advice.....	8
2.1 Explication of Symbols.....	8
2.2 Personnel Requirements.....	9
2.2.1 Qualification.....	9
2.2.2 Unauthorized Personnel.....	9
2.2.3 Instruction.....	9
2.3 Intended Use.....	10
2.4 Protective Measures to be Taken by the Operator/User.....	10
2.5 Specific Hazards.....	11
3 Short Technical Description.....	12
4 Appearance.....	12
4.1 Track Supply IP54 (air cooling).....	12
4.2 Track Supply IP54 (air-conditioned).....	13
5 Technical Data.....	14
5.1 Technical Data Outlet Specifications.....	14
5.1.1 Electrical Power Data Specifications for Versions with 400 V and 480 V.....	14
5.1.2 Electrical Input Values Specifications for Versions with 400 V.....	14
5.1.3 Electrical Input Values Specifications for Versions with 480 V.....	15
5.2 Physical Data.....	15
5.2.1 Variant with Ventilation.....	15
5.2.2 Variant with Air Conditioning.....	15
5.3 Environmental Conditions.....	16



Track Supply 6 kW IP54

80 A / 125 A at 400 V / 480 V

5.4	Mechanical Specifications	18
5.5	Connections Track Supply IP54	20
5.6	Design Standards	22
5.6.1	Design Standards for 400 V Versions.....	22
5.6.2	Additional Design Standards for 480 V Versions.....	22
5.7	Safety Features of the Track Supply Module.....	22
5.8	Grounding.....	22
5.9	ESD Protection	23
5.10	Illumination and Plug Socket Track Supply IP54	23
6	Optional Air Conditioning Unit (side mounting)	24
6.1	Version with air conditioning unit (side mounting)	24
6.2	Industrial Ethernet Interface – PROFINET or Ethernet IP	24
7	Control Board and Error Indication.....	27
7.1	Control Board of the Track Supply Module.....	27
7.1.1	LED Display	28
7.2	Control Board of the Track Supply Module.....	29
7.2.1	LED-Display.....	29
7.2.2	Version Number of the Software.....	31
7.2.3	Modes of Operation	31
7.2.4	Language Setting, Time and Date	32
7.2.5	Warning Messages	33
7.2.6	Error Codes	33
8	Fuses	36
8.1	Semiconductor Main Fuses Track Supply Module	36
8.2	Other Protective Devices (Fuses).....	36
9	Transport, Packaging and Storage	37
9.1	Transport	37
9.1.1	Safety Instructions for Transport.....	37
9.1.2	Transport Inspection	37
9.2	Packaging.....	38
9.3	Storage of Packages	38



Track Supply 6 kW IP54

80 A / 125 A at 400 V / 480 V

10	Installation	39
10.1	Who is Allowed to do the Installation?	39
10.2	General Installation Recommendations	39
10.3	Place and Conditions of Installation	40
10.4	Electrical Regulations	40
10.5	Electrical Connection	41
10.5.1	Power Connection	41
10.5.2	Connect Track Cable	42
10.5.3	External Activation Track Supply	43
10.5.4	Layout of the External Connections Track Supply Module (X2, X3, X4)	45
10.5.5	Connection of the Track Supply Module	46
11	Warnings and Precautions	48
12	Commissioning	49
12.1	Safety	49
12.2	System Conditions	49
12.3	System Protection	50
13	Start and Operation	50
14	Switch Off	51
15	Manual Operation	52
16	Emergency Measures	53
17	Fault Diagnosis	54
18	Maintenance and Servicing	55
18.1	Safety	55
18.2	Maintenance Schedule Track Supply IP54 (air cooling)	56
18.3	Maintenance Schedule Track Supply IP54 (air-conditioned variant)	57
19	Repair	58
20	Disassembly and Disposal	59
20.1	Safety	59
20.2	Reuse	59
20.3	Disassembly	60
20.4	Disposal	60



Track Supply 6 kW IP54

80 A / 125 A at 400 V / 480 V

21	Spare Parts	61
21.1	Track Supply Module	61
21.2	Track Supply IP54 Air Cooling	62
21.3	Track Supply IP54 400 V Air-Conditioned	63
22	Tools	64

ADVICE:

The names used in the following document are copyrighted as brands and are in the property of the respective companies. We reserve the right for technical modifications of illustrations and specifications in these operating instructions that serve for the improvement of the system and its functions. For system details please see the respective documentation. Always observe the system documentation for any works at the system or for the operation of the system. Reprinting and copies, even in excerpt, only with our approval.

© Conductix-Wamplfer GmbH 2013

Track Supply 6 kW IP54

80 A / 125 A at 400 V / 480 V

1 General Advice

1.1 Information About These Installation and Operating Instructions

This document facilitates safe and efficient handling and use of the equipment.

It is an integral part of the equipment and must be kept in its immediately vicinity to allow access by personnel at any time. Prior to commencing any work, the personnel must have carefully read and understood these mounting and operating instructions. It is a basic requirement for safe working that all safety and procedural instructions contained in these mounting and operating instructions are complied with.

Local accident protection regulations and general safety guidelines for the application field of the device also apply.

Illustrations in this documentation are for basic comprehension and may deviate from the real design of the equipment.

In addition to these installation and operating instructions, the attached instructions for installed components also apply.

1.2 Limitation of Liability

All information and instructions in these operating and installation instructions have been compiled with due regard to the standards and regulations in force, best engineering practice, and the findings and experience we have accumulated over many years.

The manufacturer is in no way liable for damages resulting from:

- Failure to comply with these mounting and operating instructions
- Improper use
- Use by untrained personnel
- Unauthorized modifications
- Technical changes
- Use of unauthorized replacement parts and accessories

The actual scope of delivery may differ from the explanations and illustrations described here for special variants, if additional order options are utilized, or due to the latest technical changes.

The obligations agreed upon in the delivery agreement and our General Terms of Business apply, as well as the delivery conditions of the manufacturer and all regulations applicable at the time the contract was concluded.

All products are subject to technical modifications in the context of improvement of usage properties and further development.

Track Supply 6 kW IP54

80 A / 125 A at 400 V / 480 V

1.3 Copyright

These mounting and operating instructions are subject to copyright and exclusively intended for customer internal use. Provision of the mounting and operating instructions to third parties, duplications in any form – even in part – as well as the reuse and/or disclosure of their content are not permitted without the written approval of the manufacturer, except for customer internal use.

Violations will be subject to damages. This will not exclude additional claims.

1.4 Spare Parts



WARNING!

Safety risk due to wrong spare parts!

Wrong or faulty spare parts can impair safety and result in damage, malfunction or complete failure.
- use only original spare parts of the manufacturer!

Order replacement parts from your contracted dealer or directly from the manufacturer. For the address see the last page of these operating instructions.

1.5 Material Defects

The regulations about material defects are listed in the general terms and conditions of business.

1.6 Technical Support

For technical support please contact our staff from the Customer Support Department. See the last page of these operating instructions for contact information.

Our employees are also always interested in new information and experience from the field that can be valuable for the improvement of our products.

Track Supply 6 kW IP54

80 A / 125 A at 400 V / 480 V

2 Safety Advice

2.1 Explication of Symbols

Safety and hazard information is identified in this document by symbols. Signal words are used to indicate the degree of hazard. Always observe safety instructions and work carefully to avoid accidents, personal injury or property damage!



DANGER!

... indicates an imminent dangerous situation, which may cause deadly accidents or serious injuries, if not avoided.



WARNING!

... indicates a possibly dangerous situation, which may cause deadly accidents or serious injuries, if not avoided.



CAUTION!

... indicates a possibly dangerous situation, which, if not avoided, may result in moderate or minor injury or property damage.



ADVICE!

Advice and recommendations:

... refers to useful advice and recommendations as well as information for an efficient and trouble-free operation.

Special safety notes

The following symbols are used in safety instructions to point out special risks:



DANGER!

This combination of symbol and signal word indicates an imminent dangerous situation caused by electrical power and/or electrical voltage. If a labeled hint like this is not observed this may result in serious or deadly injuries.



WARNING!

This sign draws the attention to parts of the operating instructions, where special care must be taken on account of heating of surfaces or on account of inductive heating of ferromagnetic material and where other special measures have to be taken.

Track Supply 6 kW IP54

80 A / 125 A at 400 V / 480 V

2.2 Personnel Requirements

2.2.1 Qualification



WARNING!

Risk of injury due to insufficient qualification!

Improper use can result in serious injury to persons or property damage.

- All activities may only be performed by qualified personnel!

The following qualifications are listed in these operating instructions for different areas of operation:

■ **Trained personnel/operators**

have been instructed in an instruction session by the operator with respect to the tasks assigned to them and the potential dangers arising from improper behavior.

■ **Qualified specialists**

due to their specialized training, knowledge, and experience, as well as knowledge of applicable regulations, are capable of carrying out works assigned to them, while independently recognizing and avoiding possible risks.

■ Only those persons are authorized as personnel who can be expected to perform their work reliably. People whose capacity for reaction is influenced e.g. by drugs, alcohol, or medications are not authorized.

■ When selecting personnel, follow all age- and job-related guidelines applicable at the place of operation.

2.2.2 Unauthorized Personnel



WARNING!

Danger due to unauthorized personnel!

Unauthorized personnel who do not meet the requirements described here do not understand the dangers in the working area.

- Keep unauthorized personnel away from the working area.
- In case of doubt, address these persons and direct them away from the working area.
- Stop any works as long as unauthorized personnel is in the working area.

2.2.3 Instruction

Before commissioning the equipment, the personnel must be instructed by the operator. For better tracking, log the instruction as follows:

Date	Name	Type of instruction	Instruction given by	Signature
05.11.2009	Heinz Mustermann	First instruction for personnel	Horst Müller	

Fig. 1: Example of instruction log

Track Supply 6 kW IP54

80 A / 125 A at 400 V / 480 V

2.3 Intended Use

The equipment is exclusively designed and built for the intended use described here.



WARNING!

Danger due to improper use!

Any application that deviates from or goes beyond the intended use of the devices can result in a hazardous situation.

Use the device only as intended.

- Strictly comply with all specifications in these mounting and operating instructions.

The following uses of the device are not permitted. Non-intended use particularly includes the following:

- Using the device with unapproved accessories or not authorized by the manufacturer.
- Operation of the device by untrained personnel.
- Operation of the device outdoors.
- Operation of the device when installed on an improper foundation/subsoil.

Claims of any kind due to damage from improper use are excluded. The operator is liable for all damage resulting from unintended use.

2.4 Protective Measures to be Taken by the Operator/User

The equipment is used in the industrial sector. The operator of the device is thus subject to legal obligations for operational safety. In addition to the safety guidelines in these mounting and operating instructions, the safety, accident protection, and environmental protection regulations applicable at the place of operation of the device must be followed as well. This particularly includes:

- The operator must be informed of applicable workplace safety guidelines and identify any additional hazards that result from the special working conditions at the site of operation of the device. These must be implemented in the form of operating instructions for the use of the device.
- The operator must verify during the entire operating time of the device, if the operating instructions provided still correspond to the current state of regulations, and adapt these instructions if necessary.
- The operator must clearly regulate and determine responsibilities for installation, operation, troubleshooting, and maintenance.
- The operator must ensure that all employees involved with the device have read and understood these mounting and operating instructions. He must furthermore train personnel at regular intervals and inform them about hazards.
- The operator must provide the personnel with all required safety gear.

The operator is furthermore responsible for ensuring that the device is always in a technically trouble-free condition. The following thus applies:

- The operator must ensure that the maintenance schedules described in these mounting and operating instructions will be followed.
- The operator must have all safety systems regularly inspected for proper functioning and completeness.

Track Supply 6 kW IP54

80 A / 125 A at 400 V / 480 V

2.5 Specific Hazards

These operating instructions exclusively contain notes regarding the specified Track Supply. Please note all data and advice listed in this document. Ensure that the device is operated under the specified conditions only.

ADVICE!

Do not start up the device until you have made sure that the machine/system into which it has been integrated, complies with the applicable norms and directives!

We must point out that we will not accept any liability for damage and breakdown that have been caused due to not observing these operating instructions.

The following section lists residual risks that have been determined by a risk assessment.

- Follow the safety instructions listed here and the warnings in other sections of these mounting and operating instructions in order to reduce health hazards and avoid dangerous situations.



DANGER!

Electric shock and/or burns and other damage due to improper use!

The device is operated with high voltage and high currents.

- Do not open the device during operation.
- Do not remove covers.
- Do not insert any objects into the device.

The Track Supply has a weight of approx. 240 kg (variant with air conditioning approx. 300 kg) and must not be lifted or carried by a single person. It must be lifted or transported with appropriate auxiliaries. The relevant prescriptions must be observed, see chapter 5 „Technical Data“.



WARNING!

Risk of injury due to insufficient qualification!

Improper use can result in serious injury to persons or property damage.

- All works for installation and commissioning as well as for maintenance and disassembly must be carried out by qualified staff (observe IEC 364 resp. CENELEC HD 384 or DIN VDE 0100 and IEC 664 or DIN VDE 0110 and the national accident prevention regulations).

ADVICE!

Qualified staff, according to the safety regulations, are persons that are familiar with the installation, assembly, commissioning and operation of energy supply systems and that have the appropriate qualifications.

We must point out that we will not accept any liability for damage and breakdown that have been caused due to not observing these operating instructions.

These operating instructions only contain details of the component “Track Supply”.

Track Supply 6 kW IP54

80 A / 125 A at 400 V / 480 V

3 Short Technical Description

The Track Supply serves for the energy supply of the secondary components within a defined area of the system. The Track Supply converts the supply voltage of 400 V / 50 Hz or 480 V / 60 Hz into a constant sinusoidal current of 20 kHz. The AC supply to the primary track of a system constitutes a local magnetic field where power is transmitted. In this way the galvanically isolated power transmission to the point of consumption (e.g. Pickups) will be possible.

4 Appearance

4.1 Track Supply IP54 (air cooling)

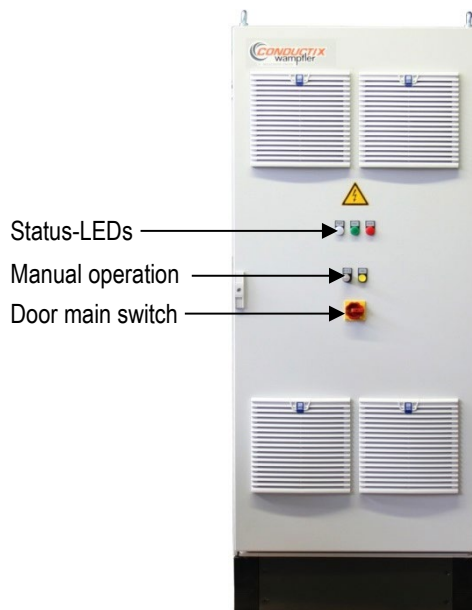

Fig. 1: 400 V version



Fig. 2: View without door

Existing variants:

91008-111-3130927 (80 A, 400 V)

91012-111-3130928 (125 A, 400 V)

91008-111-3130929 (80 A, 480 V)

91012-111-3130930 (125 A, 480 V)



Please note that in some cases the above figure is not exactly in conformity with the supplied Track Supply (e.g. the color could be different or the cable connections could be at another place). If you are not sure that you have been delivered the right part, please contact a person at Conductix-Wampfler.

Track Supply 6 kW IP54

80 A / 125 A at 400 V / 480 V

4.2 Track Supply IP54 (air-conditioned)

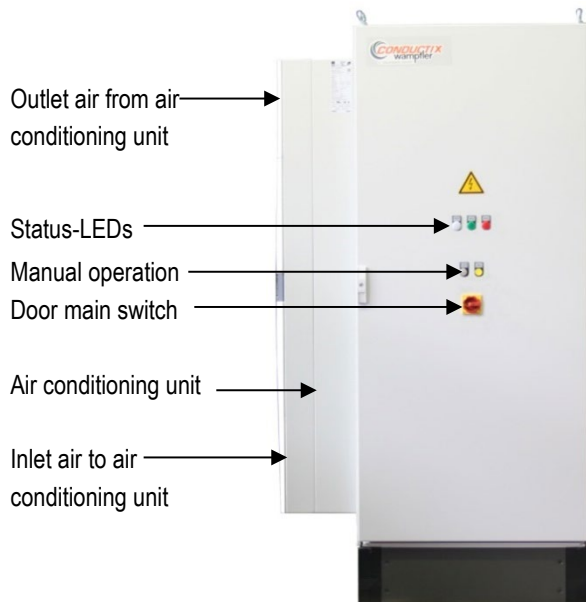

Fig. 3: Variant with air conditioning



Fig. 4: View without door

Device configurable via
91000-111-3131371

i
ADVICE!

Please note the advice regarding place of installation and separation distance in chapter 6 „Optional Air Conditioning Unit (side mounting)“.

Track Supply 6 kW IP54

80 A / 125 A at 400 V / 480 V

5 Technical Data

5.1 Technical Data Outlet | Specifications

5.1.1 Electrical Power Data | Specifications for Versions with 400 V and 480 V

- Nominal power (cont.) 6 kW
- Peak power 137% (8 kW) for max. 1 minute / 10 minutes at 40°C,
with an average reduction of the load up to 4,9 kW
- Output current 80 A or 125 A +/- 2 A @ 20 kHz +/- 50 Hz
- Optimum load of line inductance 58 μ H +2 μ H for 80 A Track Supply
26 μ H +2 μ H for 125 A Track Supply
- Nominal output voltage range 560 - 665 V rms (80 A), 380 - 475 V rms (125 A)
Overloading increases the voltage.
- Output impedance to PE 180 Ω (center capacitive referenced)
- Primary cable connection M8 stainless steel screws for 35 mm² and 20 mm² HF stranded cable
Max. connecting torque range 9-10 Nm

5.1.2 Electrical Input Values | Specifications for Versions with 400 V

- Input voltage 400 V / 50 Hz, 3 phases symmetrically, with grounded neutral conductor
- Supply voltage tolerance -10% to +10%, with proportional power reduction for
input voltages that deviate from the nominal value
- Efficiency with nominal load 94%
- Power factor (cos ω) 0.78
- Supply current 12 A with nominal output / voltage
- Connection to terminals M40 cable gland
Maximum cable diameter is 28 mm.
Use of flexible cables 4x16 mm².
- Internal leakage current 16 mA rms at standby. Occasionally pulse peak performance of 200 mA for
250 μ sec with nominal load. If used, the earth connection equipment must
have the respective nominal values.
- Internal fuses 50 A protection of Track Supply
20 A equipment and wiring protection
- Harmonic currents (nominal load) 5. -4,5 dB, 7. -9 dB, 11. -21,6 dB, 13. -21,7 dB (on foundation)

Track Supply 6 kW IP54

80 A / 125 A at 400 V / 480 V

5.1.3 Electrical Input Values | Specifications for Versions with 480 V

■ Input voltage	480 V / 60 Hz, 3 phases symmetrically, with grounded neutral conductor
■ Supply voltage tolerance	-10% to +10%, with proportional power reduction for input voltages that deviate from the nominal value
■ Efficiency with nominal load	94%
■ Power factor (cos ω)	0.78
■ Supply current	10 A with nominal output / voltage
■ Connection to terminals	M40 cable gland The cable outer diameter is 28 mm. Use of a flexible cable 4x16 mm ² .
■ Internal leakage current	19 mA rms at standby. Occasional pulse peak power of 200 mA for 250 μ sec at nominal load. If used, the earth connection equipment must have the respective nominal values.
■ Internal fuses	40 A protection of Track Supply 10 A equipment and wiring protection
■ Harmonic currents (nominal load)	5. -4,3 dB, 7. -9,1 dB, 11. -18,7 dB, 13. -19,7 dB (on foundation)

5.2 Physical Data

5.2.1 Variant with Ventilation

■ Noise emission	during operation 65 dBA at 2 m distance from the device
■ Moving air volume	2 x 700 m ³ / hours (air circulation)
■ Ventilator	2 axial ventilator
■ Protection class	IP54

5.2.2 Variant with Air Conditioning

■ Ventilation/cooling	air conditioning unit type RITTAL TopTherm SK 3328.540
■ Ventilator	axial ventilator (internal air circulation)
■ Noise emission air conditioning unit	during operation 65 dBA at 2 m distance from the device
■ Protection class	IP54

Track Supply 6 kW IP54

80 A / 125 A at 400 V / 480 V

5.3 Environmental Conditions

- Storage temperature: -20 °C to +60 °C
- Transport temperature -20 °C to +70 °C
- Ambient temperature + 5 °C to +35 °C (with ventilator) / + 5 °C to +50 °C (with air conditioning)
Power reduction -3% / °C between 40 °C and 55 °C (At the inside!)



WARNING!

Damage due to extreme differences in temperature!

Frozen and very cold internal components might be the cause for damage of the device or its components at them moment of switch-on or with fast/strong loads.

If the storage temperature or ambient temperature is lower than the specified operating temperature, proceed as follows prior to commissioning the device:

- Store the device unloaded and switched-off for at least 12 hours with operating temperature.



WARNING!

Damage due to strong and frequent temperature changes!

Strong and immediate temperature changes will result in a reduction of the life time.

If the device is exposed to strong and frequent temperature changes during operation, the following measures must be taken:

- Demand-oriented heating/cooling of the device.
- Avoid condensation of the humidity.
- Avoid pumping effects due to temperature changes.

- Humidity < 90% non-condensing
- Ambient air No salt water, no conductive dry or humid dust! (e.g. carbon fibers)
Extreme ambient conditions must be avoided (e.g. very dusty, oily and/or chemical influence)
- Power reduction at high altitudes 1% of the power/ 100 m over 1000 m, up to max. 3000 m above sea level
- IP protection class IP54 for air-conditioned variant (IP34 for external circuit air conditioning unit)
IP54 for air cooled variant
- Degree of pollution PD = 2. Non-conducting pollution existing. This might temporarily become conducting, if humidity is present after switch-off.
- Maximum vibration 3 mm at 2 - 9 Hz, max. Acceleration 0.5 g at 9 - 200 Hz
- Maximum shock resistance 8 g, 11 ms
- Max. transport vibration 15 g, 11 ms packed / transport container



ADVICE!

The Track Supply requires sufficient air supply for a correct cooling. Ensure that the air supply is free at any time. The filters must be inspected for dust and oil clogging and be replaced if required.

Track Supply 6 kW IP54

80 A / 125 A at 400 V / 480 V

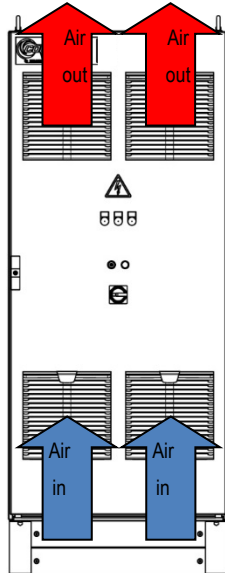

Fig. 5: Variant without air conditioning

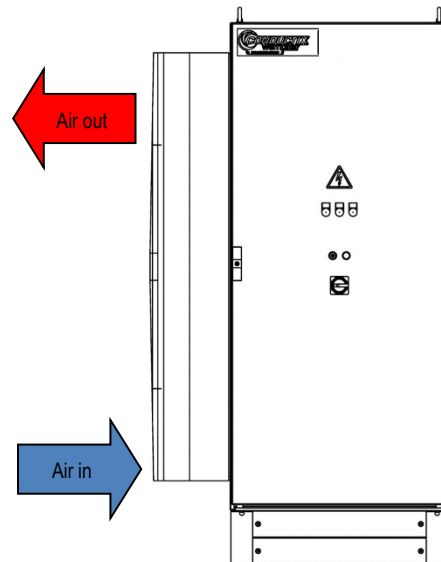

Fig. 6: Variant with air conditioning

Room around the housing: Sufficient air supply must be secured!

Recommended distances:

- 400 mm in front of the Track Supply with ventilator
- 100 mm behind the Track Supply
- 100 mm from the side of the Track Supply with ventilator
- 400 mm from the side of the Track Supply with air conditioning unit (at the side of the air conditioning unit)

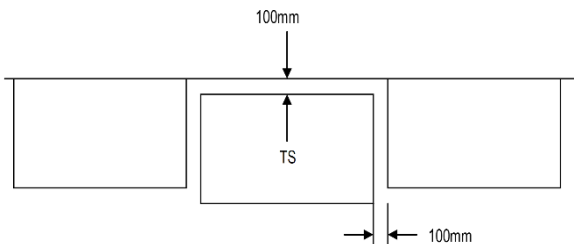

Fig. 7: Position Track Supply from the top (variant without air conditioning unit)

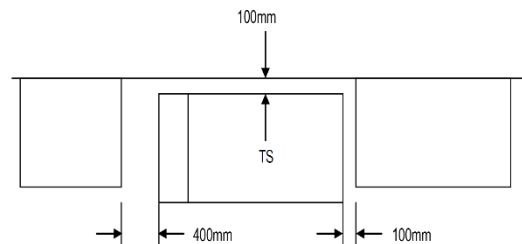

Fig. 8: Position Track Supply from the top (variant with air conditioning unit)



ADVICE!

The Track Supply must be fixed at the floor. Observe the specifications of the housing manufacturer.



ADVICE!

Screened cables are not obligatory. But they are recommended for the improvement EMC. To avoid induced voltages at 20 kHz, you should avoid to install the control cables and other cables near the primary conductor and especially not more than 5 m along this one. Twisted two-wired lines help to reduce the capacitive coupling effect. The screening should be grounded on one side.

Track Supply 6 kW IP54

80 A / 125 A at 400 V / 480 V

5.4 Mechanical Specifications

■ Housing	Steel sheet housing RITTAL TS8 with door at the right
■ Locking	Standard locking for RITTAL TS8-housing
■ Door hinges	130° opening angle
■ Dimensions	See figure
■ Housing color (outside)	RAL XXXX; for the actual color see the type label ¹
■ Housing color (inside)	RAL 7035 „light gray”
■ Housing color foundation	RAL 7022 „umbra-gray”
■ Weight (with ventilation)	~ 240 kg
■ Weight (with air-conditioning)	~ 300 kg

91008-111-3130927 (80 A, 400 V, ...)

91012-111-3130928 (125 A, 400 V, ...)

91008-111-3130929 (80 A, 480 V, ...)

91012-111-3130930 (125 A, 480 V, ...)

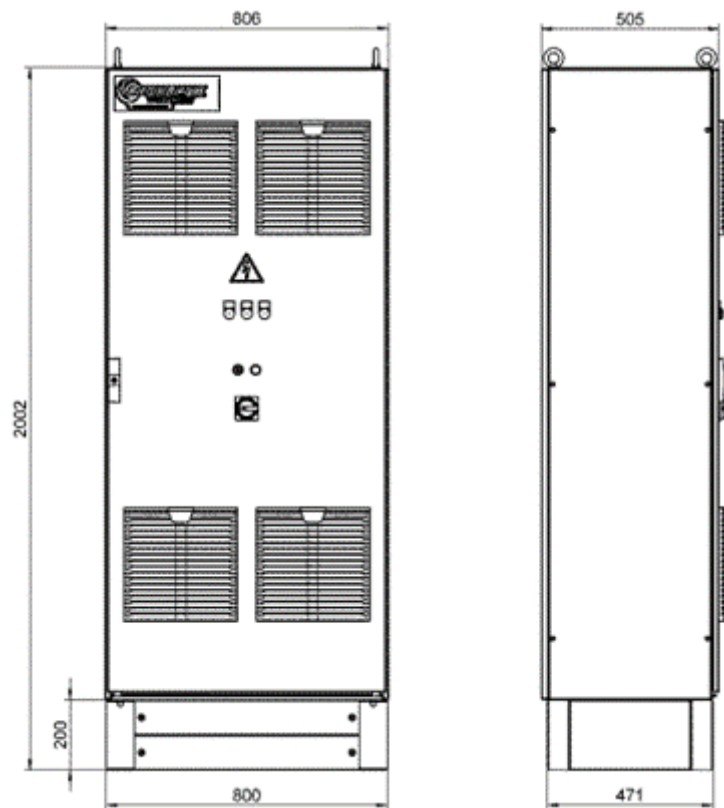

Fig. 9: Dimensions variant without air-conditioning

¹ Colors are configurable and have to be specified with the order.

Track Supply 6 kW IP54

80 A / 125 A at 400 V / 480 V

91000-111-3131371 (configurable version - with air-conditioning)

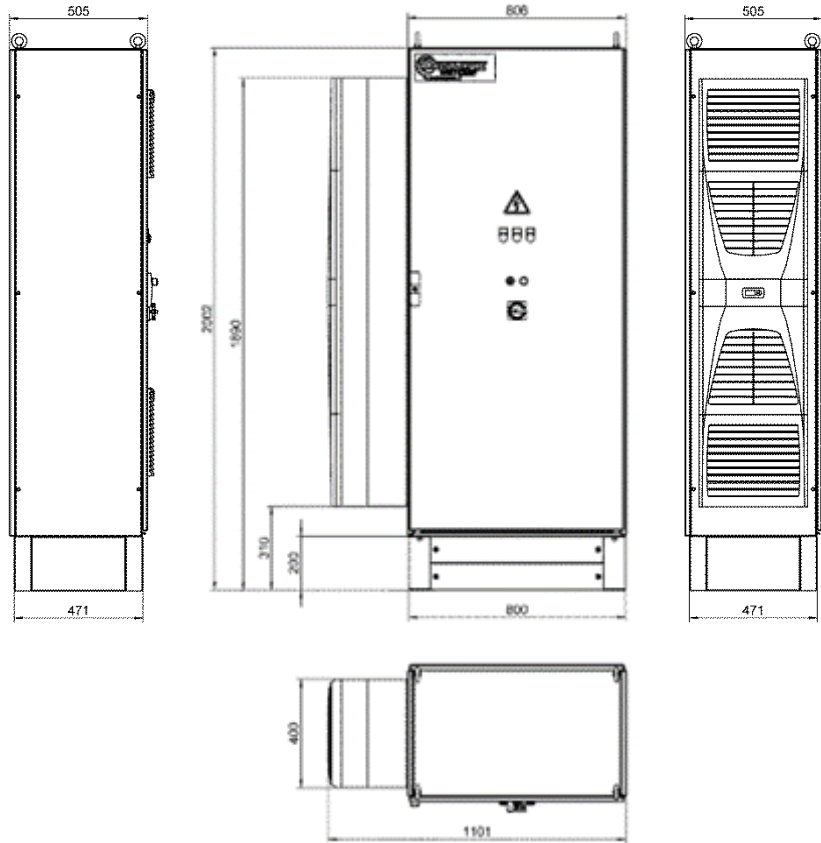

Fig. 10: Dimensions variant with air-conditioning

Track Supply 6 kW IP54

80 A / 125 A at 400 V / 480 V

5.5 Connections | Track Supply IP54



Connections track cables 1+2 directly in the Track Supply module
(Connections according to section 10.5.2 „Connect Track Cable “)

Connections Track Supply IP54 via terminal strip

PIN	Function	Comment:
1	Track cable 1	20 (80 A) - 35 (125 A) mm ² cable lugs soldered HF stranded cable ²
2	Track cable 2	

400 V version: Connection to AC network (terminal 1X2)

No.	Function	Current	Comment:
L1	L1	63 A	I depends on load and input voltage
L2	L2	63 A	I depends on load and input voltage
L3	L3	63 A	I depends on load and input voltage
PE	PE		

Alternative

480 V version: Connection to AC network (terminal 1X2)

No.	Function	Current	Comment
L1	L1	50 A	I depends on load and input voltage
L2	L2	50 A	I depends on load and input voltage
L3	L3	50 A	I depends on load and input voltage
PE	PE		

² Cable lugs with M8-opening. Permissible only soldered!

Track Supply 6 kW IP54

80 A / 125 A at 400 V / 480 V

Control (terminal 5X3)

No.	Function	Voltage / current	Comment
1	Start	24 V DC / 20 mA	+24 V
2			24 V present = Start
3	Reset	24 V DC / 20 mA	+24 V
4			0 V = Reset
5	Supply messages	230 V AC 24 V DC	Common voltage supply for messages terminal 6, 11 and 12
6	Dysfunction Track Supply		Potential-free contact; typically closed, in case of dysfunction open
7	24 V DC		For internal use only
8	0 V		Potential-free contact; closed = ok
9	Synchronization	±15 V	
10	Synchronization		
11	Control voltage on		Potential-free contact closed = on; open = off
12	Dysfunction voltage supply		Potential-free contact; typically closed, in case of dysfunction open

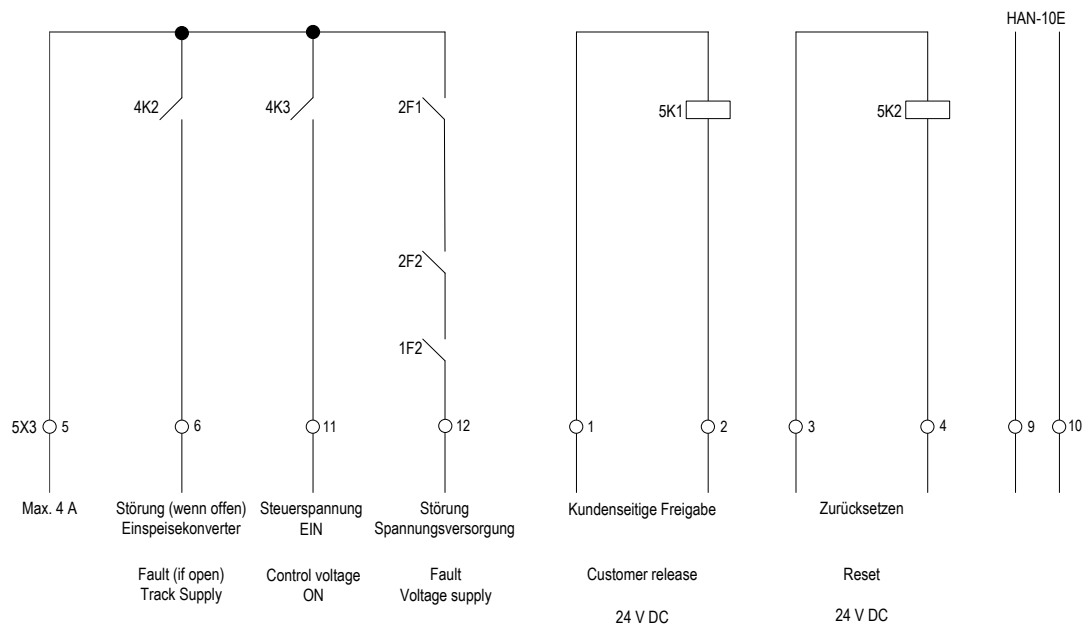

Fig. 11: Terminal configuration

Further details, see chapter 10.5 „Electrical Connection“.

Track Supply 6 kW IP54

80 A / 125 A at 400 V / 480 V

5.6 Design Standards

5.6.1 Design Standards for 400 V Versions

- EN 50178 Equipment of power plants with electronic equipment; German version EN 50178: 1997
- EN 61000-6-2 Electromagnetic compatibility (EMC) - part 6-2: General information Standards - interference resistance in the industrial sector
- EN 55011 Industrial, scientific and medical high frequency units (ISM-units) – radio interference Limit values and measurement process (IEC/ CISPR 11: 1997)

5.6.2 Additional Design Standards for 480 V Versions

- UL 508A Standards for industrial controls

5.7 Safety Features of the Track Supply Module

- | | |
|---|--|
| ■ Overheating | 4 installed temperature sensors and switches |
| ■ Overloading | Output overload control |
| ■ Overcurrent | Internal current monitoring |
| ■ Overvoltage | Output voltage control |
| ■ Grounding connection error monitoring | Trigger level adjustable |
| ■ Current sensor error detection | Recognizes if the sensor feed does not work properly. |
| ■ Deviation on tuning | Monitoring of the tuning and recognition of a no longer correct installation |
| ■ Phase loss | Recognizes if a phase of the power supply is missing |
| ■ Power network isolation at the output | 2500 V AC for 1 min. |
| ■ Fuses | Installed fuses |

5.8 Grounding

The Track Supply must be grounded by qualified personnel at the place of installation and preferably to a three-phase network with grounded neutral point. Even if the Track Supply with supply systems with other type of grounding works, e.g. delta grounding works well, the electromagnetic compatibility and reliability can be negatively affected.

Metal structure, which are running close to or in parallel to the primary conductor over longer sections, must in any case be grounded by qualified personnel. To achieve the best possible results, multiply grounding will be required. To avoid induced voltages at 20 kHz, you should avoid to install the control cables and other cables near the primary conductor and especially not more than 5 m along this one. Twisted two-wired lines help to reduce the capacitive coupling effect. The screening should be grounded at one end.

Track Supply 6 kW IP54

80 A / 125 A at 400 V / 480 V

5.9 ESD Protection



WARNING!

Electrostatically endangered components!

Electrostatic discharges (ESD) might damage electronic components.

- Comply with the respective ESD measures before and during the complete works at the open device, e.g. by means of a grounding bracelet.
- Connection to the ground must be assured any time. Details see EN 6100.

5.10 Illumination and Plug Socket | Track Supply IP54



← Illumination and maintenance socket Track Supply IP54



Fig. 12: Illumination



Fig. 13: Socket integrated into illumination unit

The installed illumination unit can be switched on and off via the integrated motion sensor or a switch.



ADVICE!

To conserve the illuminant we recommend to use the illumination only when carrying out works at the Track Supply IP54.



WARNING!

Danger of destruction / overloading due to improper utilization or too strong loads!

- The socket must only be used with appropriate plugs!
- The load of the socket must not exceed 2 A. Devices with higher power requirements must not be operated at the integrated plug!

Track Supply 6 kW IP54

80 A / 125 A at 400 V / 480 V

6 Optional Air Conditioning Unit (side mounting)

6.1 Version with air conditioning unit (side mounting)

The air conditioning is located at the left side of the Track Supply. During installation, ensure that there is enough space (min. 400 mm) to other cabinets and walls, to allow an unobstructed airflow (see chapter 4 “Appearance“ and chapter 5.3 „Environmental Conditions“). For more details regarding operation and maintenance of the air conditioning unit see the manufacturer’s documents.



In case of a change, observe the connection of the air conditioning unit with the correct polarity according to the documentation of the manufacturer.

ADVICE!

6.2 Industrial Ethernet Interface – PROFINET or Ethernet IP

An Industrial Ethernet interface is optionally available for the feed converter model 3130914 (Configurable version). The interface (-7X1) is located in the bottom of the track supply. If a track supply TS is ordered with this option, the appropriate (external) plug is supplied to connect to -7X1.

Plug type: PLUG CONNECTOR RJ45 CAT5 IP65 SCREANED (Han PP V14 RJ45 Cat5 Stvb 4p IDC 6.5-9.5)

A sample project including instructions (TI9100-0075) for integration into an existing PLC project can be downloaded from the Conductix-Wamplifier website at the following link:

https://www.conductix.com/sites/default/files/downloads/TI9100-0075-DE_Track_Supply_Anybus_and_Config.zip

The sample project is implemented and tested with the following hardware and software:

- Siemens Simatic Step7 V5.5 + SP4 K5.5.4.0
- Siemens CPU 314C-2 PN/DP V3.3
- HMS Anybus Communicator AB7013-C / V3.03

Description of the Software-Interface

Beschreibung	Name	Type	Kommentar
Input	I_RemoteStart	BOOL	Remote start signal
Input	I_RemoteReset	BOOL	Remote reset signal
Input	LADDR_Input_1	WORD	Peripheral starting-address for function DPRD_DAT of input_1
Input	LADDR_Input_2	WORD	Peripheral starting-address for function DPRD_DAT of input_2
Input	LADDR_Input_3	WORD	Peripheral starting-address for function DPRD_DAT of input_3
Input	LADDR_Input_4	WORD	Peripheral starting-address for function DPRD_DAT of input_4
Input	LADDR_Input_5	WORD	Peripheral starting-address for function DPRD_DAT of input_5

Track Supply 6 kW IP54

80 A / 125 A at 400 V / 480 V

Beschreibung	Name	Type	Kommentar
Input	LADDR_Input_6	WORD	Peripheral starting-address for function DPRD_DAT of input_6
Input	LADDR_Output_1	WORD	Peripheral starting-address for function DPWR_DAT of output_1
Output	RemoteStart	BOOL	Feedback from remote start signal
Output	RemoteReset	BOOL	Feedback from remote reset signal
Output	LocalStart	BOOL	Feedback from local start signal
Output	LocalReset	BOOL	Feedback from local reset signal
Output	Isoln2	BOOL	
Output	DIP1	BOOL	Feedback DIP-Switch 1 on TSCB
Output	DIP2	BOOL	Feedback DIP-Switch 2 on TSCB
Output	DIP3	BOOL	Feedback DIP-Switch 3 on TSCB
Output	DIP4	BOOL	Feedback DIP-Switch 4 on TSCB
Output	OVERLOAD_WARNING	BOOL	
Output	OVERTEMP_WARNING	BOOL	
Output	RTC_WARNING	BOOL	
Output	TUNING_WARNING	BOOL	
Output	INIT_STATE	BOOL	
Output	DISABLED_STATE	BOOL	
Output	BOOT_STATE	BOOL	
Output	ENABLED_STATE	BOOL	
Output	ERROR_STATE	BOOL	
Output	SUSPENDED_STATE	BOOL	
Output	SHUTDOWN_STATE	BOOL	
Output	DS1820_Temp1	INT	Temperature in [°C]
Output	DS1820_Temp2	INT	Temperature in [°C]
Output	NTC_Temp1	INT	Temperature in [°C]
Output	NTC_Temp2	INT	Temperature in [°C]
Output	Query_Count	INT	Number of requests from ABC to TSCB
Output	Response_Count	INT	Number of answers from TSCB to ABC
Output	Errorcode	INT	See manual
Output	E001	BOOL	Error phase loss
Output	E002	BOOL	Error IGBT
Output	E003	BOOL	Error internal current hardware limit
Output	E004	BOOL	Error ground fault
Output	E005	BOOL	Error door open
Output	E006	BOOL	Error no track current
Output	E007	BOOL	Error temperature high on sensor 1
Output	E008	BOOL	Error temperature high on sensor 2

Track Supply 6 kW IP54

80 A / 125 A at 400 V / 480 V

Beschreibung	Name	Type	Kommentar
Output	E009	BOOL	Error temperature sensor 1 defect
Output	E010	BOOL	Error temperature sensor 2 defect
Output	E011	BOOL	Error temperature high on heat sink sensor 1
Output	E012	BOOL	Error temperature high on heat sink sensor 2
Output	E013	BOOL	Error heat sink temperature sensor 1 short circuited
Output	E014	BOOL	Error heat sink temperature sensor 1 open circuited
Output	E015	BOOL	Error heat sink temperature sensor 2 short circuited
Output	E016	BOOL	Error heat sink temperature sensor 2 open circuited
Output	E017	BOOL	Error temperature switch 1 open circuited
Output	E018	BOOL	Error temperature switch 2 open circuited
Output	E019	BOOL	Error LCD
Output	E020	BOOL	Error output track voltage high
Output	E021	BOOL	Error output track current high
Output	E022	BOOL	Error output power high
Output	E023	BOOL	Error soft-start
Output	E024	BOOL	Error watchdog
Output	E025	BOOL	Error brownout
Output	E026	BOOL	Error track supply output open circuited
Output	E027	BOOL	Error DC bus voltage high
Output	E028	BOOL	Error DC bus voltage low
Output	E029	BOOL	Error internal current software limit
Output	E030	BOOL	Error DC bus voltage unstable
Output	E031	BOOL	Error inductance high
Output	E032	BOOL	Error inductance low
Output	E033	BOOL	Error 3.3V on board power supply failure
Output	E034	BOOL	Error 3.3V on board power supply failure
Output	E035	BOOL	Error 3.3V on board power supply failure
Output	E036	BOOT	Error 3.3V on board power supply failure
Output	E037	BOOT	Error 5V on board power supply failure
Output	E038	BOOT	Error 24V control board supply failure
Output	E039	BOOT	Error FPGA configuration
Output	E040	BOOT	Error FPGA SPI bus
Output	E041	BOOT	Error invalid output voltage measurement
Output	E042	BOOT	Error invalid output current measurement
Output	E043	BOOT	Error invalid internal current measurement
Output	E044	BOOT	Error oscillator
Output	E045	BOOT	Error FPGA software
Output	E046	BOOT	Error zone controller 1

Track Supply 6 kW IP54

80 A / 125 A at 400 V / 480 V

Beschreibung	Name	Type	Kommentar
Output	E047	BOOL	Error zone controller 2
Output	E048	BOOL	Error DIP switcher
Output	E049	BOOL	Error output peak power high
Output	ret_val_input_1	INT	Error-code from function DPRD_DAT for input_1
Output	ret_val_input_2	INT	Error-code from function DPRD_DAT for input_2
Output	ret_val_input_3	INT	Error-code from function DPRD_DAT for input_3
Output	ret_val_input_4	INT	Error-code from function DPRD_DAT for input_4
Output	ret_val_input_5	INT	Error-code from function DPRD_DAT for input_5
Output	ret_val_input_6	INT	Error-code from function DPRD_DAT for input_6
Output	ret_val_output_1	INT	Error-code from function DPWR_DAT for output_1

7 Control Board and Error Indication

7.1 Control Board of the Track Supply Module

The control board is installed at the upper part of the Track Supply and will become visible when the cover of the housing is open.



There are two conductor plates existing:

- Control board
- Indicator circuit board above the control board, see chapter 7.2 „Control Board of the Track Supply Module“

Fig. 14: Control board when the cover of the Track Supply module has been removed

Track Supply 6 kW IP54

80 A / 125 A at 400 V / 480 V

7.1.1 LED Display

Usually the LEDs are only visible when the cover is open and/or other protective covers have been removed. These LEDs therefore serve for further fault analysis. Both green LEDs (V503 and V504) show the correct function of the installed power supplies (12 V and 5 V) and should always be switched off.

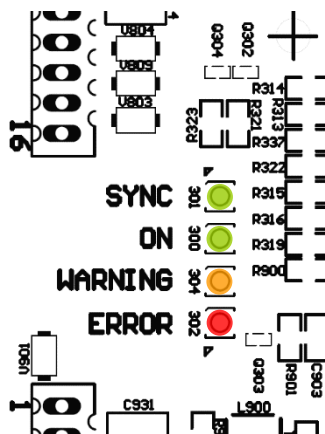

The four LEDs on the control board inform about the operational state of the Track Supply:

- SYNC (synchronization) (green LED)
- ON (switched-on) (green LED)
- WARNING (yellow LED)
- ERROR (fault) (red LED)

The displays of the LEDs „on“, „warning“ and „error“ correspond to one of the three LEDs each, that are located on the indicator circuit board of the Track Supply, see chapter 7.2.1 „LED-Display“. In addition to that the „Sync“-LED indicates if a synchronization of an external 20 kHz signal is existing or not.

Track Supply 6 kW IP54

80 A / 125 A at 400 V / 480 V

7.2 Control Board of the Track Supply Module

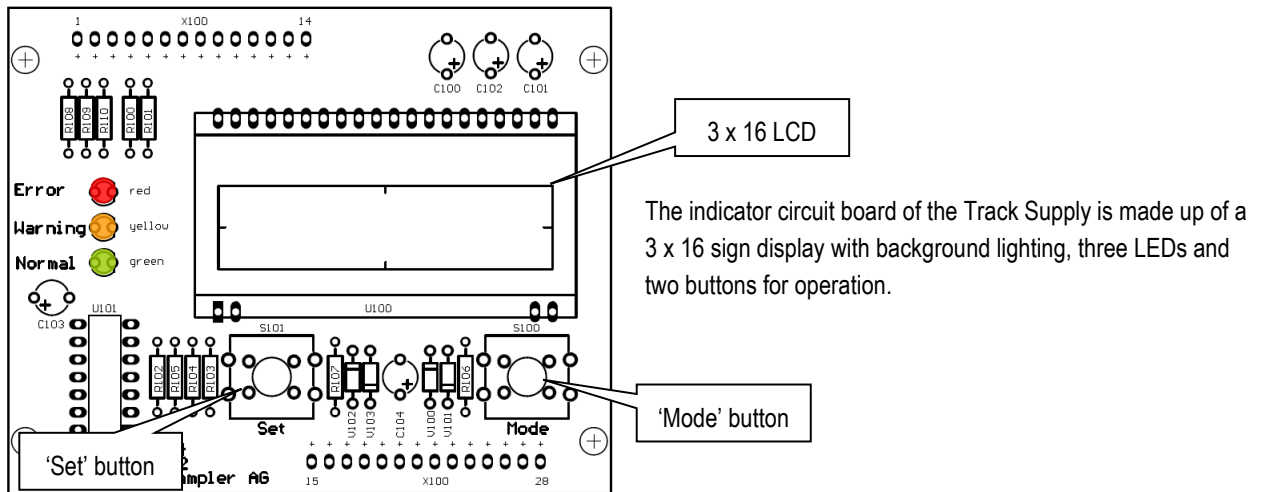

The indicator circuit board of the Track Supply is made up of a 3 x 16 sign display with background lighting, three LEDs and two buttons for operation.

7.2.1 LED-Display







The three LED of the indicator circuit board show the following states:

green LED	Meaning	Cause
Off	Track Supply without power supply or error → see red LED	Possible causes: ■ Track Supply not connected to the power supply ■ Problem control board
Flashing	Track Supply in standby mode	Normal state at missing START signal on HAN-10E
On	Track Supply works	Normal state: The signals for START and reset are available at the HAN-10E
red LED	Meaning	Cause
Off	Track Supply without power supply or without error → see green LED	Normal state, if no error existing.
Flashing	Track Supply in reset mode	Normal state due to the not existing signal for reset on HAN-10E
On	Error Track Supply → see yellow LED / LCD	See error code on display. Error codes are described in chapter 7.2.6.

Track Supply 6 kW IP54

80 A / 125 A at 400 V / 480 V

The yellow LED warns the operating personnel of critical operational states. Such warning messages do not stop the Track Supply. If, however, a warning is not noticed, this can cause an error. If more than one warning messages are existing, only the most important one will be displayed (in the following table the events are arranged from top to bottom with increasing importance. Example: If there are both warning for tuning and overloading, the overload warning LED will be switched on. In any case the LCD indicates both warnings, see chapter 7.2.5.

Yellow LED	Meaning	Cause
 Off	No warnings	
1 short flashing every 2 seconds 	Real-time warning (RTC ³ warning)	The real-time clock stopped due to a too weak battery and might indicate wrong data. But the Track Supply continues to operate. However errors will no longer be displayed with the correct date. Prior to changing the battery, switch off the power supply to the Track Supply! 
2 times short flashing every 2 seconds 	Tuning warning	Track inductance too low or too high. The Track Supply can continue to operate, but excess temperature may occur. Causes: <ul style="list-style-type: none"> ■ Wrong commissioning ■ Pickups added after commissioning ■ Damaged track tuning capacitors ■ Track/feeds repositioned or lengthened
Slow flashing 	Excess temperature warning	One or several of the following causes: <ul style="list-style-type: none"> ■ Air supply or air removal blocked ■ Ventilator(s) blocked or defective due to dust ■ Heat sink blocked due to dust ■ Overload due to high loads ■ Ambient temperature is too high The Track Supply can continue to operate, but an excess temperature error may occur.
 On	Overload warning	Too many consumers on the system/in the feeding section. The Track Supply will continue to operate, but an excess temperature, excess current or excess voltage may occur.

³ RTC = Real Time Clock

Track Supply 6 kW IP54

80 A / 125 A at 400 V / 480 V

7.2.2 Version Number of the Software

After switching on the LCD-display a start indication will be displayed for 5 seconds with the serial number of the software version, the compile time and the compile date. The Track Supply can start its function prior to the expiration of these 5 seconds. This depends on the START input.

```
Version 1234567a
13:07
May 17, 09
```

7.2.3 Modes of Operation

During operation the LCD shows some basic information to the operating mode of the Track Supply. The following operating modii have been defined:

The Track Supply is supplied with voltage, but there is no correct signal at the reset input. Output is deactivated.

```
-----RESET-----
No warnings
```

The Track Supply is supplied with voltage, but there is no correct signal at the START input. Output is deactivated.

```
----STANDBY----
No warnings
```

The Track Supply works normally.

```
----OPERATION---
No warnings
```

```
RROR-----
15:01
26.05.09
```

The Track Supply has recognized an error. The error code is displayed together with date and time of its appearance. Regarding error code see chapter 7.2.6. Output is deactivated.

Track Supply 6 kW IP54

80 A / 125 A at 400 V / 480 V

7.2.4 Language Setting, Time and Date

Below the LCD you will find two buttons, by which the operating personnel can change the basic settings. These settings can be made in each operational state, except in the RESET mode.



If the RESET mode is selected (no signal at RESET) while modifications are being made, these will get lost.

ADVICE!

To change setting, press the button MODE for 5 seconds. When this time has expired the display looks like in the figure at the right. With each pressing on the SET button another one of the four languages will be displayed:

- English
- French
- German
- Italian

SELECT LANGUAGE
English

By pressing the MODE button you will get to the next setting, as illustrated below.

The time setting will be displayed in a 24-hours format hh:mm. The buttons have the following functions:

- Pressing and holding the SET-button steps up the setting that is marked by the cursor.
- Pressing the MODE-button puts the cursor on the minutes setting or the date setting.

SET TIME
15:01
hh:mm

The date is appears in formati tt.mm.jj. The buttons have the following functions:

- Pressing and holding the SET-button steps up the setting that is marked by the cursor.
- Pressing the MODE-button puts the Cursor to the next setting or the next page to set.

SET DATE
26:05.09
tt:mm:jj

If changes have to be made, the user is asked for his confirmation or cancellation of those.

- Pressing the MODE-button will cancel the changes.

SAVE?
Yes No

- Pressing the SET-button will store the new settings, which is confirmed by the display as shown on the right side.

SETTINGS saved!

Track Supply 6 kW IP54

80 A / 125 A at 400 V / 480 V

7.2.5 Warning Messages

While staying in the operational mode RESET, STANDBY and OPERATION, additional warning messages can be displayed. These are indicated by the state of the yellow LEDs. If there is more than one warning at the same time, these will be indicated one after the other at secondary frequency. The following warning messages can occur:

- No warnings
- Warning tuning
- Warning temperature
- Warning overload
- Warning time of the day

Regarding a detailed description and possible reasons, see chapter 7.2.1 „LED-Display“.

7.2.6 Error Codes



WARNING!

Danger of injury due to improper fault elimination!

Improper fault elimination can result in serious injury or property damage.

- Contact the manufacturer in case of malfunction.
- Allow fault elimination to be carried out only by personnel from or authorized by the manufacturer.

Please note that one and the same problem can result in different error codes, depending on when it appears. This happens because the error monitoring methods and response times are different for each type of error, as well as the sequential processing on the part of the microprocessor. If an error has been recognized the subsequent errors will be ignored and not displayed.

Error code	Description	Meaning/cause
E001	Phase loss	<ul style="list-style-type: none"> ■ Phase of the input line missing or too weak ■ Fuse(s) triggered ■ Fuse mounting is not closed or is not properly screwed
E002	IGBT-error	<ul style="list-style-type: none"> ■ IGBT or IGBT-driver defective ■ EMC-interruption ■ Use of 400 V TS with 480 V supply
E003	Internal current limiting activated	<ul style="list-style-type: none"> ■ High peak load ■ Track cable is interrupted or not connected ■ Track tuning faulty
E004	Earth-fault	<ul style="list-style-type: none"> ■ Isolation of the Track Supply or the track cable is damaged ■ Water on the track ■ Ground current error level set too low
E005	Door open	<ul style="list-style-type: none"> ■ Pin 11 and 12 of X104 are not bridged ■ Loose connection
E006	No track current	<ul style="list-style-type: none"> ■ Track current sensor or connection cable defective
E007	High temperature at sensor 1	<ul style="list-style-type: none"> ■ Air supply or air removal blocked ■ Overload due to high loads

Track Supply 6 kW IP54

80 A / 125 A at 400 V / 480 V

Error code	Description	Meaning/cause
		<ul style="list-style-type: none"> ■ Ambient temperature too high ■ Tuning condensers damaged ■ Axial fan defective / fan fuse triggered
E008	High temperature at sensor 2	See E007
E009	Temperature sensor 1 defective	<ul style="list-style-type: none"> ■ Sensor defective ■ Loose connection
E010	Temperature sensor 2 defective	<ul style="list-style-type: none"> ■ Sensor defective ■ Loose connection
E011	High temperature at sensor 1 cooling body	See E007
E012	High temperature at sensor 2 cooling body	See E007
E013	Temperature sensor 1 at cooling body has a short circuit	<ul style="list-style-type: none"> ■ Connection problem of the temperature sensor
E014	Connection to temperature sensor 1 on cooling body interrupted	<ul style="list-style-type: none"> ■ Connection problem of the temperature sensor
E015	Temperature sensor 2 at cooling body has a short circuit	<ul style="list-style-type: none"> ■ Connection problem of the temperature sensor
E016	Connection to temperature sensor 2 on cooling body interrupted	<ul style="list-style-type: none"> ■ Connection problem of the temperature sensor
E017	Temperature switch 1 interrupted	<ul style="list-style-type: none"> ■ Loose connection ■ See E007
E018	Temperature switch 2 interrupted	<ul style="list-style-type: none"> ■ Loose connection ■ See E007
E019	LCD	<ul style="list-style-type: none"> ■ LCD defective ■ Loose connection between display and control board
E020	Output voltage (track) high	<ul style="list-style-type: none"> ■ Track tuning faulty
E021	Output voltage (track) high	<ul style="list-style-type: none"> ■ Error control board
E022	Output power too high	<ul style="list-style-type: none"> ■ To many consumers on track or too high power demand
E023	Soft start error	<ul style="list-style-type: none"> ■ Soft start circuit error
E024	Watchdog	<ul style="list-style-type: none"> ■ Software problem
E025	Voltage drop	<ul style="list-style-type: none"> ■ Voltage error at supply control board ■ Power supply error at the control board
E026	Output track supply interrupted	<ul style="list-style-type: none"> ■ Track cable is not connected ■ Track cable is damaged or interrupted
E027	Intermediate circuit voltage high	<ul style="list-style-type: none"> ■ Mains overvoltage e.g. flash or other disturbance ■ Secondary Pickup load suddenly removed
E028	Intermediate circuit voltage low	<ul style="list-style-type: none"> ■ Phase of the power supply missing, e.g. fuse not triggered ■ Low power supply
E029	Software limit internal current	<ul style="list-style-type: none"> ■ High peak load ■ Track cable is interrupted ■ Track tuning faulty

Track Supply 6 kW IP54

80 A / 125 A at 400 V / 480 V

Error code	Description	Meaning/cause
E030	Intermediate circuit voltage instable	<ul style="list-style-type: none"> ■ When switching on the device it was not possible to read out a stable voltage on the intermediate circuit due to a power supply disturbance
E031	High inductivity	<ul style="list-style-type: none"> ■ Track tuning condenser aging, error or loose connections ■ Faulty commissioning ■ After commissioning pickups have been added ■ Track cable / feed line has been modified or extended after commissioning
E032	Inductance low	<ul style="list-style-type: none"> ■ Track tuning condenser aging, error or loose connections ■ Faulty commissioning ■ After commissioning pickups have been added ■ Track cable / feed line has been modified or extended after commissioning
E033	Error of the 3.3 V power supply	<ul style="list-style-type: none"> ■ Communications power supply overload/error
E034	Error of the 3.3 V power supply	<ul style="list-style-type: none"> ■ Micro power supply overload/error
E035	Error of the 3.3 V power supply	<ul style="list-style-type: none"> ■ Analogous power supply overload/error
E036	Error of the 3.3 V power supply	<ul style="list-style-type: none"> ■ FPGA current supply overload/error
E037	Error of the 5 V power supply	<ul style="list-style-type: none"> ■ 5 V power supply overload/error
E038	Error 24 V control board supply	<ul style="list-style-type: none"> ■ 24 V power supply overload/error ■ 24 V on HAN 10 is used externally in an improper way
E039	FPGA configuration error	<ul style="list-style-type: none"> ■ FPGA error ■ Flash memory error ■ SPI bus problem
E040	FPGA SPI bus error	<ul style="list-style-type: none"> ■ SPI bus problem
E041	Invalid measurement of the output voltage	<ul style="list-style-type: none"> ■ FPGA error
E042	Invalid measurement of the output current	<ul style="list-style-type: none"> ■ FPGA error
E043	Invalid measurement of the internal current	<ul style="list-style-type: none"> ■ FPGA error
E044	Oscillator error	<ul style="list-style-type: none"> ■ Error of the micro-oscillator
E045	FPGA software error	<ul style="list-style-type: none"> ■ Software incompatible
E046	Zone controller 1 error	<ul style="list-style-type: none"> ■ Error message of external zone controller
E047	Zone controller 2 error	<ul style="list-style-type: none"> ■ Error message of external zone controller
E048	DIP switch	<ul style="list-style-type: none"> ■ Incorrect DIP switch position
E049	Output peak power high	<ul style="list-style-type: none"> ■ To many consumers on track or too high power demand ■ See E022

Track Supply 6 kW IP54

80 A / 125 A at 400 V / 480 V

8 Fuses

8.1 Semiconductor Main Fuses | Track Supply Module



DANGER!

Danger of electric shock!

The Track Supply is de-energized only if the voltage supply has been interrupted for at least 20 minutes by switching off or unplugging the power plug.

- Wait at least 10 minutes after switch-off, so that voltages of the intermediate circuit condensers can fall down to < 60 V DC.

For control and replacement of the main fuses observe the following:

- Remove the Track Supply from the power supply voltage and protect it from a restart or resetting.
- **Before** you open the Track Supply wait at least 10 minutes so that the internal discharge can fall down to < 60 V DC.
- Remove the safety cover (left cover)
- Then check the condition of the fuses.



ADVICE!

If one of the fuses must be replaced, please always replace all three fuses together! Only use the prescribed fuses. See chapter 21 „Spare Parts“.

- Ensure that the fuses are properly seated and receptacle is fully closed.
- Replace the cover into its position and restart the operation of the Track Supply.
- Connect the Track Supply to the mains supply and switch it on again.

8.2 Other Protective Devices (Fuses)

The Track Supply is equipped with several automatic fuses and protective switches. These must only be replaced after having consulted Conductix-Wampller. In the event of the repair the Track Supply must be disconnected from the mains supply and an appropriate time must be considered for discharging processes (approx. 10 minutes to let the voltage drop to < 60 V DC).



ADVICE!

A reset of the automatic fuses is not permissible, as long as the Track Supply is connected to the mains supply!

Track Supply 6 kW IP54

80 A / 125 A at 400 V / 480 V

9 Transport, Packaging and Storage

9.1 Transport

9.1.1 Safety Instructions for Transport



CAUTION!

Damage from improper transport!

Improper transport can result in substantial property damage.

- Proceed with care when unloading packaged parts upon delivery or during internal transport, and observe the symbols and notes on the packaging.
- Only move, lift and transport the track supply with appropriate lifting and transport equipment (weight see chapter 5.4 „Mechanical Specifications“).
- When using a forklift or similar transport device, ensure that the housing will not be damaged.
- Only remove packaging material immediately prior to starting the installation.

9.1.2 Transport Inspection

Check the shipment for completeness and transport damage immediately upon receipt.

If transport damage is externally visible, proceed as follows:

- Do not accept the shipment, or accept it only with reservations.
- Note the scope of damage on the transport documents or on the transporter's delivery note.
- Initiate a complaint.



ADVICE!

Claim every defect as soon as it is detected. Damage compensation claims may only be made within the applicable claim periods.

Track Supply 6 kW IP54

80 A / 125 A at 400 V / 480 V

9.2 Packaging

The individual packages must be packed according to the transport conditions to be expected. Only environmentally friendly materials have been used for packaging.

The packaging must protect the individual components from transport damage, corrosion and other damage until the installation will be made. Therefore do not destroy the packaging and remove it only immediately before the installation.

Handling of packaging materials:

Dispose of packaging material according to the valid legal regulations and local guidelines.



CAUTION!

Environmental damage due to improper disposal!

Packaging material is a valuable resource and can be reused, processed or recycled in many cases.

- Dispose of packaging materials in an environmentally appropriate manner.
- Observe the locally applicable disposal guidelines; if necessary, engage a specialist for disposal.

9.3 Storage of Packages

Store packages under the following conditions:

- Do not store outdoors.
- Store in a dry and dust-free place.
- Do not expose to aggressive media.
- Protect from direct sunlight.
- Avoid mechanical vibrations.
- Storage temperature: -20°C to +60°C
- Humidity: < 90% non-condensing
- When storing for more than 3 months, check the general condition of all parts and the packaging at regular intervals. If necessary renew or replace the preservative.



ADVICE!

Under some circumstances, there may be instructions for storage on the packages which go beyond the requirements listed here. Follow them appropriately.

Track Supply 6 kW IP54

80 A / 125 A at 400 V / 480 V

10 Installation

10.1 Who is Allowed to do the Installation?



WARNING!

Risk of injury due to insufficient qualification!

Improper use can result in serious injury to persons or property damage.

- All works for installation and commissioning as well as for maintenance and disassembly must be carried out by qualified staff (observe IEC 364 resp. CENELEC HD 384 or DIN VDE 0100 and IEC 664 or DIN VDE 0110 and the national accident prevention regulations).
- All works for installation und commissioning must be carried out according to these mounting instructions. Any notes listed in this document must be strictly observed. It is moreover required to observe the general national prescriptions and specific factory regulations.



ADVICE!

Qualified staff, according to the safety regulations, are persons that are familiar with the installation, assembly, commissioning and operation of energy supply systems and that have the appropriate qualifications.

10.2 General Installation Recommendations

- After having received the component(s) and prior to starting the installation works unpack the components and check exactly for any damage, that may have occurred due to transport or storage (damage at the housings and isolation, missing parts etc.).
- Check the data on the identification plate to make sure that the components fulfill the requirements regarding nominal power and voltage.
- Ensure and verify completeness of the documents, if the documents comply with the supplied component(s).
- If several Track Supplies are applied in one single system, it may be possible that they must be synchronized. Conductix-Wamplifier provides the documentation with the synchronization components.
- Prior to the installation ensure that the Track Supply is securely placed on a plane subsoil. The Track Supply must be fixed on site so that it will have a safe position under all circumstances.
The balance point of the Track Supply is in the center. Observe the instructions of the housing manufacturer to fix the housing at the floor! For the fixation use components recommended by the manufacturer.
- For the installation of the Track Supply ensure that it is mounted safely and firmly. It must be fixed on site so that a safe position of the Track Supply will always be ensured.



ADVICE!

Wrong installation of the current supply has some negative effects on function, efficiency and lifetime. It is therefore important to observe the specification regarding the determination of the installation site. If this is not observed the warranty will expire!

Track Supply 6 kW IP54

80 A / 125 A at 400 V / 480 V

10.3 Place and Conditions of Installation

Install the Track Supply in a dry and ventilated space. The Track Supply must be installed in a vertical position and mounted onto a solid subsoil or to a solid wall.

The waste heat of the Track Supply will be dissipated by ventilators via outlet openings in the housing or via the laterally installed air conditioning unit. Therefore absolutely ensure during the assembly that the air flow at the intake and outlet opening will not be hindered – see chapter 6 „Optional Air Conditioning Unit (side mounting)“.

The ambient temperature should not be below 5°C and must not exceed the Conductix-Wampfler specification of 35°C at a ventilator or 50°C at an air conditioning unit. The relative humidity should be below 90% and there must not be any condensation. Any negative ambient conditions must be avoided.

Any application beyond these conditions may result in changes of the performance parameters. For further information, see chapter 5 „Technical Data“.

The climatic conditions for the storage and operation must be observed according to the specifications, see chapter 5.3 “Environmental Conditions“.

A distance of 100 mm laterally between adjacent cabinets and behind the Track Supply to the wall as well as a distance of 400 mm from the air conditioning unit is recommended for a maximum performance, especially if adjacent devices produce heat as well.

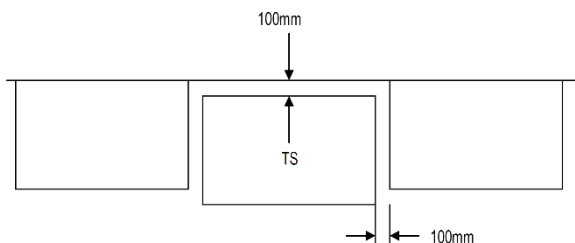

Fig. 15: Position Track Supply IP54 from above
(Variant without air conditioning)

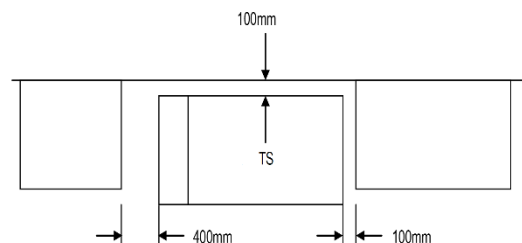

Fig. 16: Position Track Supply IP54 from above
(Variant with air conditioning)

10.4 Electrical Regulations

The general electrical working conditions according to VDE 0100 (installation and operation of equipment up to 1000 V) must be observed. If necessary, observe the local regulations if those go beyond these requirements.

The fuses in the Track Supply serve for damage limitation in the Track Supply, if components are faulty. The feed line from the power connection to the Track Supply must be protected properly according to the local regulations.

Track Supply 6 kW IP54

80 A / 125 A at 400 V / 480 V

10.5 Electrical Connection

10.5.1 Power Connection

The electric cables for the supply lines L1, L2, L3 and PE must be chosen as follows:

1. Use connecting cables that have been approved according to VDE, UL and CUL, according to the local requirements.
2. The Track Supply has been designed for connection to a neutrally grounded 3-phase supply system. Although it is possible to use alternative supply system, such as delta grounding, we do not recommend those, since those could lead to the expiration of the warranty. If you should have any doubts about that, please contact Conductix-Wampfler.
3. The nominal voltage of the cables for systems with 480 V AC must be at least 600 V.
4. The core cross section must be planned according to the respective standards, however we recommend minimum 2.5 mm².
5. The grounding must be made according to VDE, NEC and IEC, see chapter 5.8 „Grounding“.
6. The 3-phase supply connection to 1X2 requires a flexible cable for the connection. The maximum outside diameter for the cable is 18 mm with the accompanying PG21/M32 cable gland.



ADVICE!

To avoid damage of the input fuses Conductix-Wampfler recommends to remove the 3-phase power connection only if the START/STOP-signal is in the position "STOP". A delay of at least 0.5 seconds is recommended!

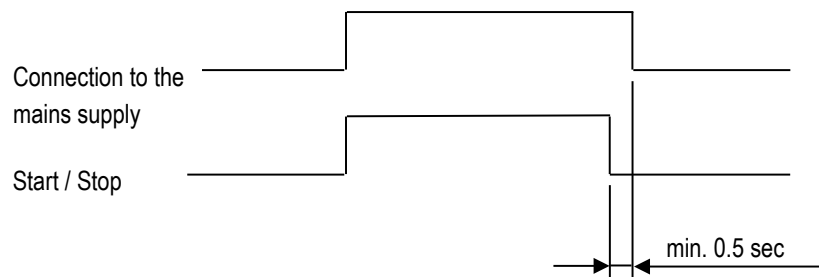

Track Supply 6 kW IP54

80 A / 125 A at 400 V / 480 V

10.5.2 Connect Track Cable

Introduce the track cables through the cable glands into the Track Supply and fix it to the side wall by means of plastic clamps.



Both cables should be bundles together as close as possible. This also applies for the distance from the side wall to the Track Supply module.

ADVICE!

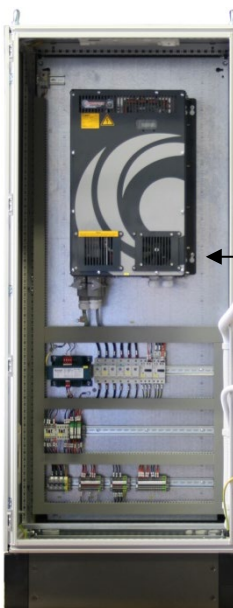

Fig. 17: Cable guide track cable

Torque for the track cable connections X1.1 and X1.2: 9 – 10 Nm.

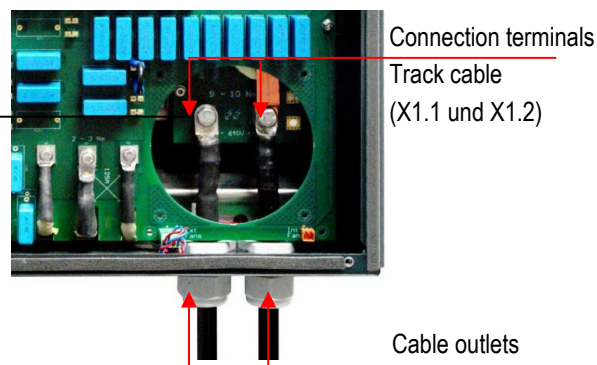

Fig. 18: Connection track cable



Fig. 19: Connection track cable with mounted cover plate

Example figure above: Cable connection through the opening on the right side. For the fixation of the stainless steel M8 screws use a torque von 9 to 10 Nm. Fuses are behind the left hand cover.

Track Supply 6 kW IP54

80 A / 125 A at 400 V / 480 V

10.5.3 External Activation Track Supply

Inputs:

/Reset	Reset+ (Pin 3) must be made at 24 V DC via Reset- (Pin 4), otherwise the Track Supply remains in the reset state Note: to reset the Track Supply, Reset must be low for at least 0.5 seconds.
Start	24 V DC and grounding can be used to switch the Track Supply on or off. If Start+ (Pin 1) is taken 24 V DC above Start- (Pin 2) the Track Supply output will be energized. Otherwise the outputs are disabled.
Sync	For synchronizing several Track Supplies to the same frequency and phase. Use only equipment that has been approved by Conductix-Wampfler. If several Track Supplies shall be used on one distance, these should be synchronized since otherwise performance restrictions might occur.

Both the input Start and Reset are optically isolated.

Outputs:

Error	Switch is open on error or if the mains supply is disconnected. Otherwise it is closed.
0 and 24 V	May be used for control and commissioning, but must not be distributed over cables longer than 2 m. May be used for commissioning.

In and outputs Track Supply module

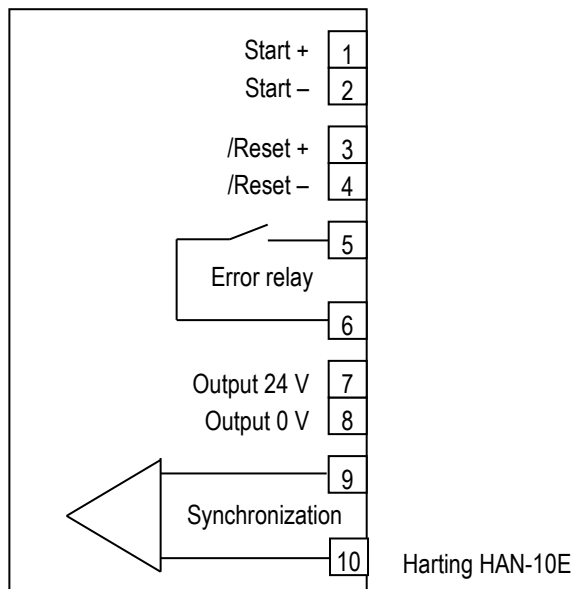

WARNING!

Do not locally distribute this 24 V DC supply output over control cables! Do not reference 0 V to other potentials!

Operating and Maintenance Instructions



Track Supply 6 kW IP54

80 A / 125 A at 400 V / 480 V

Track Supply 6 kW IP54

80 A / 125 A at 400 V / 480 V

10.5.4 Layout of the External Connections Track Supply Module (X2, X3, X4)

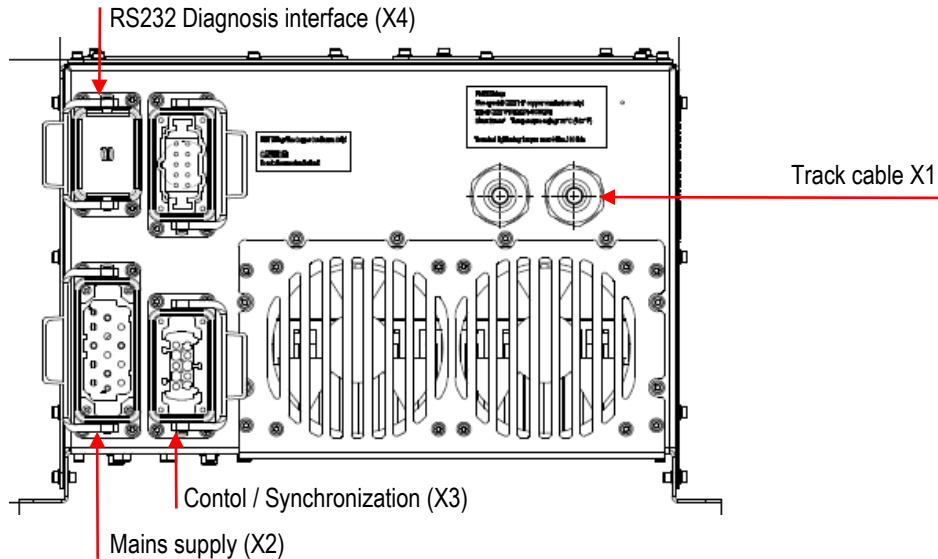

Housing bottom Track Supply module



ADVICE!

Ensure that the cable ends are long enough to make connections. Conductix-Wampfler recommends to use a flexible cable.

Track Supply 6 kW IP54

80 A / 125 A at 400 V / 480 V

10.5.5 Connection of the Track Supply Module

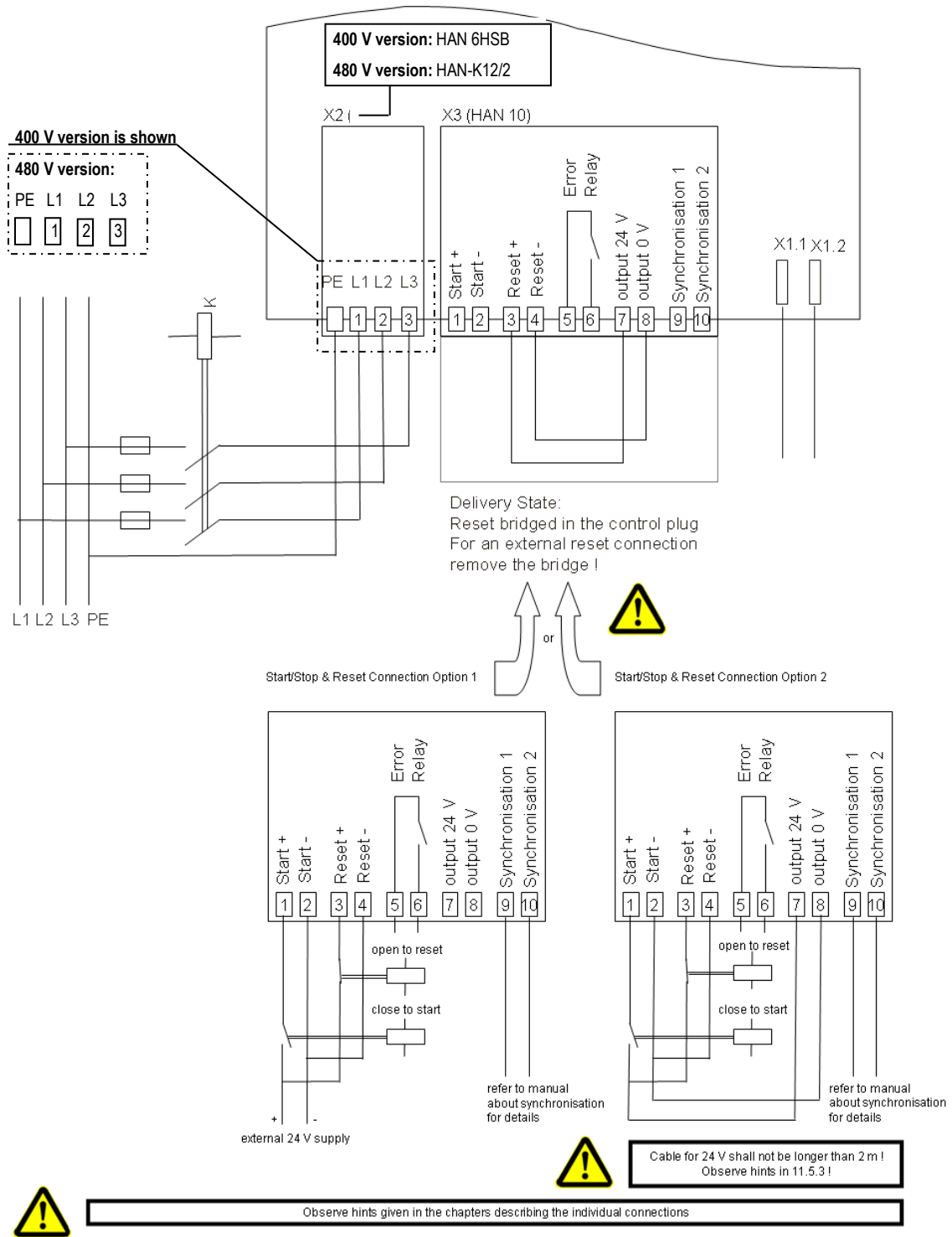

Track Supply 6 kW IP54

80 A / 125 A at 400 V / 480 V



DANGER!

Danger of electric shock!

The Track Supply is de-energized only when the plug or the power supply is disconnected for more than 20 minutes.

- Prior to opening the Track Supply wait at least 20 minutes!
- Observe the safety regulation and ensure that nobody else has access to the open Track Supply.



ADVICE!

To get better access to the internal components, the cover plates (on the side and in the front) can be removed.



Fig. 20: Track Supply module released



ADVICE!

For an ease and quick access to the fuses and the cable connections you can remove the specific covers at the housing front.



Example figure above: Cable connection through the opening on the right side. For the fixation of the stainless steel M8 screws use a torque of 9 to 10 Nm. Fuses are behind the left cover.

Track Supply 6 kW IP54

80 A / 125 A at 400 V / 480 V

11 Warnings and Precautions



DANGER!

Danger of life due to electric shock!

Although the Track Supply is isolated from the mains supply by a transformer, the output with ground conductor is equipped with Y-connected noise suppressing condensers. This means a potential voltage exists with respect to the PE that might cause electric shock and even death.

- Do not touch unisolated parts of the mains supply!
- Do not touch any electrical components of the Track Supply power supply!
- Observe safety precautions before and after covers and housing have been removed.
- Avoid risk of life by appropriate safety measures!



DANGER!

Danger due to improper use!

The Track Supply is only intended for operation in connection with other, accordingly dimensions components.

- If you are not sure that this is the case, contact Conductix-Wampfler. Do not start operation of the Track Supply/system in this case!



WARNING!

Interference of the operation by intrusion of dirt and dust!

Operation of the Track Supply without its covers may allow the intrusion of dirt and dust, thereby reducing the functioning and reliability according to the specification.

- Avoid operation with removed covers and/or open cover.
- Tighten cable glands at the lower end in the housing and ensure that the covers are screwed properly. All cable connections in the housing must be fixed.



WARNING!

Risk of injury due to insufficient qualification!

Improper use can result in serious injury to persons or property damage.

- All works for installation and commissioning as well as for maintenance and disassembly must be carried out by qualified staff (observe IEC 364 resp. CENELEC HD 384 or DIN VDE 0100 and IEC 664 or DIN VDE 0110 and the national accident prevention regulations).
- All works for installation and commissioning must be carried out according to these mounting instructions. Any notes listed in this document must be strictly observed. It is moreover required to observe the general national prescriptions and specific factory regulations.



ADVICE!

Qualified staff, according to the safety regulations, are persons that are familiar with the installation, assembly, commissioning and operation of energy supply systems and that have the appropriate qualifications.

Track Supply 6 kW IP54

80 A / 125 A at 400 V / 480 V

12 Commissioning

12.1 Safety

Track Supplies have to be commissioned in connection with the respective components of the rail systems. For commissioning it is necessary to mount the secondary components (Pickups and Regulators) on all vehicles. Access to secondary Pickups and Regulators on all vehicles is necessary.

The primary system has to be installed completely before commissioning Track Supplies. Commissioning on site requires the correct adjustment of the primary track cable impedance where the Track Supply is connected to. For the general operation of the inductive energy supply system the local conditions will be considered and optimum resonance conditions for the system will be provided with the help of condensers and coils. These adjustments at the Track Supply must be only be made by trained personnel.



WARNING!

Danger due to unauthorized personnel!

Unauthorized personnel who do not meet the requirements described here do not understand the dangers in the working area.

- Keep unauthorized personnel away from the working area.
- Identify dangerous areas by warning signs and secure those with a barrier tape from access by unauthorized persons are from contact with current-carrying components.
- In case of doubt, address these persons and direct them away from the working area.
- Stop any works as long as unauthorized personnel is in the working area.

For the implementation of the commissioning the following requirements must be fulfilled:

- Free access to the site.
- Free access to the voltage supply.
- Free access to all components.
- Safe storage of the equipment required for commissioning (components, tools, auxiliaries etc.).
- Possibility to remove or to short-cut Pickups.
- Possibility to add load to the Pickups / power regulators step by step.
- Access to the external control signals to the Track Supply.



ADVICE!

Any changes to the system (e.g. more vehicles) or in the environment after commissioning requires additional commissioning.

12.2 System Conditions

The permissible transient fluctuation of the system voltage is between -10% and +10% of the nominal voltage. If the values are lower or higher than these, the technical data of the Track Supply cannot be guaranteed any longer and destruction of some components may be the consequence.

Track Supply 6 kW IP54

80 A / 125 A at 400 V / 480 V

12.3 System Protection

The system operator must install fuses or overload switches in the area of the power input according to the relevant regulations of the NEC and all local regulations. The operation level must be coordinated with the internal fusing and the expected load.

13 Start and Operation

The Track Supply is not designed for independent operation. It has to be operated in connection with other corresponding rail components. Therefore no specific details about the operation are given in this document. Prior to switching-on the Track Supply ensure that the installation and commissioning have been implemented properly. Always observe the valid safety regulations!



DANGER!

Danger of life due to electric shock!

After having connected the Track Supply to the line voltage the components of the power circuit are connected to the voltage network as well.

- Never touch these components!
- Keep all doors and covers closed.



WARNING!

Danger of injury due to improper operation!

Improper operation can result in serious injury to persons or property damage.

- Carry out all operating steps according to the specifications of these operating instructions.
- Before starting work, ensure that all covers and safety systems are installed and are working properly.
- Never put safety systems out of order during operation.



WARNING!

Danger for unauthorized personnel!

Unauthorized personnel who do not meet the requirements described here do not understand the dangers in the working area.

- Keep unauthorized personnel away from the working area.
- In case of doubt, address these persons and direct them away from the working area.
- Stop any works as long as unauthorized personnel are in the working area.

Track Supply 6 kW IP54

80 A / 125 A at 400 V / 480 V

Start sequence:

1. Ensure that "OFF" is set as an external START signal.
2. If an external switch has been installed between the main distribution and Track Supply switch it on now.
3. Put key switch on AUTO
4. Switch on the Track Supply by switching the START-input to "ON".
→ LED "switching" must be flashing now on the control board.
5. The system is now ready for operation.



Prior to any intervention into an electrical or mechanical component of the energy supply system, always disconnect the complete system always from the supply voltage! Connecting and disconnecting measuring instruments is only permitted under off-circuit conditions and must only be carried out by trained personnel.



Reconstruction or modifications at the energy supply system or its components on one's own authority are excluded from the guarantee. Any necessary reconstructions or modifications - especially on electrical components - are only permitted if approved by Conductix-Wamplifier.

14 Switch Off

As already described in chapter 10.5 „Electrical Connection“ the Track Supply shall always be switched off via the external START-input "OFF" prior to disconnecting the supply voltage (i.e. by a load disconnecter).



Danger of electric shock!

The Track Supply is de-energized only if the voltage supply has been interrupted for at least 20 minutes by switching off or unplugging the power plug.

- After having disconnected the energy supply system from the supply voltage, do not touch any components of the power connections.
- Wait at least 10 minutes after switch-off before starting any works at the energy supply system or its component, so that voltages of the intermediate circuit condensers can fall down to < 60 V DC.



The lifetime of the components can be extended by switching off the Track Supply when the system is not required, e.g. during the night or on weekends.

Track Supply 6 kW IP54

80 A / 125 A at 400 V / 480 V

15 Manual Operation

For commissioning, tests or if an external control for the release of the Track Supply is not available, a manual start release is possible.



DANGER!

Danger of life due to electric shock!

After having connected the Track Supply to the line voltage the components of the power circuit are connected to the voltage network as well.

- Never touch these components!
- Keep all doors and covers closed.



WARNING!

Danger of injury due to improper operation!

Improper operation can result in serious injury to persons or property damage.

- Carry out all operating steps according to these operating instructions.
- Before starting work, ensure that all covers and safety systems are installed and are working properly.
- Never put safety systems out of order during operation.



WARNING!

Danger for unauthorized personnel!

Unauthorized personnel who do not meet the requirements described here do not understand the dangers in the working area.

- Keep unauthorized personnel away from the working area.
- In case of doubt, address these persons and direct them away from the working area.
- Stop any works as long as unauthorized personnel are in the working area.

Start sequence:

1. Ensure that "OFF" is set as an external START signal.
2. If an external switch has been installed between the main distribution and Track Supply switch it on now.
3. Switch on the Track Supply by setting the key switch to ON.
→ LED "switching" must be flashing now on the control board.
4. The system is now ready for operation.
5. Errors can be quit by activating the RESET button

Track Supply 6 kW IP54

80 A / 125 A at 400 V / 480 V

16 Emergency Measures



DANGER!

Danger of electric shock!

The Track Supply is de-energized only if the voltage supply has been interrupted for at least 20 minutes by switching off or unplugging the power plug.

- Wait at least 10 minutes after switch-off before starting any works at the energy supply system or its component, so that voltages of the intermediate circuit condensers can fall down to < 60 V DC.



WARNING!

Risk of personal injury or property damage!

In the event of smoke or sparks in the housing or danger of personal injury or property damage, immediately disconnect the Track Supply from the power supply.

- Set the main switch at the door to "OFF".
- Pull power plug HAN-6HSB.



ADVICE!

Unauthorized switching on by a third person has to be prevented by removing the line fuses of the mains supply or by other adequate measures on site.



ADVICE!

The dangerous zone has to be provided with warning signs and secured with a shutoff tape against entry by unauthorized people.

Track Supply 6 kW IP54

80 A / 125 A at 400 V / 480 V

17 Fault Diagnosis

In case of faults at the Track Supply, e.g. no energy supply to the secondary components, check the display for indication of a possible cause. See chapter 7 „Control Board and Error Indication“ regarding the conditions.



Attempts to repair or restart should be avoided! Do not use the system anymore as long as the error has not been located and repaired or defective components have been replaced by trained personal!

ADVICE!

After conclusion of the failure analysis, the Track Supply has to be protected against touching of live parts by closed housing / covers. See safety advice in chapter 10.2 „General installation recommendations“.

Error display at the outside:

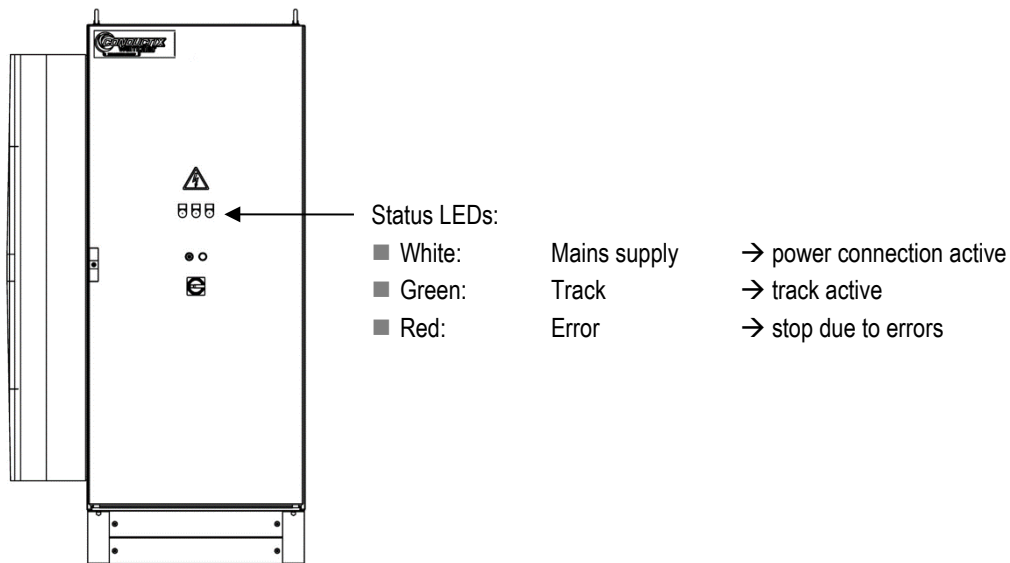

Fig. 21: Variant with optimum air conditioning unit

For a detailed error analysis, see chapter 7 „Control Board and Error Indication“.



For notes regarding error display of the air conditioning unit see the documentation of the manufacturer.

ADVICE!

Track Supply 6 kW IP54

80 A / 125 A at 400 V / 480 V

18 Maintenance and Servicing

18.1 Safety



WARNING!

Danger of injury due to improperly executed maintenance tasks!

Improper maintenance can result in serious personnel injury or property damage.

- Before starting work, ensure that there is sufficient space for assembly.
- Maintain order and cleanliness in the assembly area! Loosely stacked or scattered components and tools are a source of accidents.
- If components have been removed, be careful to reinstall them properly, replace all fastening elements, and observe screw tightening torques.



WARNING!

Risk of injury due to insufficient qualification!

Improper use can result in serious injury to persons or property damage.

- All works for installation and commissioning as well as for maintenance and disassembly must be carried out by qualified staff (observe IEC 364 resp. CENELEC HD 384 or DIN VDE 0100 and IEC 664 or DIN VDE 0110 and the national accident prevention regulations).
- All works for installation and commissioning must be carried out according to these mounting instructions. All the notes listed in this document must be strictly observed. It is moreover required to observe the general national prescriptions and specific factory regulations.



ADVICE!

Qualified personnel, according to the safety regulations, are persons that are familiar with the installation, assembly, commissioning and operation of energy supply systems and that have the appropriate qualifications.

Track Supply 6 kW IP54

80 A / 125 A at 400 V / 480 V

18.2 Maintenance Schedule Track Supply IP54 (air cooling)

The tasks carried out according to the maintenance schedule must be logged. If regular inspections reveal increased wear, the corresponding maintenance intervals should be shortened in accordance with the actual signs of wear. In case of any questions regarding maintenance tasks and intervals, contact the manufacturer; see service address on the last page.



DANGER!

Danger of electric shock!

During maintenance and repair work the Track Supply must be secured against unexpected and unintended switch on.

- Prior to starting maintenance works disconnect the Track Supply from the mains supply!

The following maintenance work should be carried out every 3 months:

- Visual inspection for external damage and damage due to special ambient conditions (e.g. damage of the housing cover, splash water, oil etc.)
- Inlet and outlet air are free - free airflow must be ensured. Ensure that the airflow and the air ducts are not blocked by any objects. Polluted filter pads must be replaced by new ones.
- Ensure that the Track Supply is dry, clean and free from dust and oil. If the Track Supply is very dirty, check the IP-protection and contact Conductix-Wampller regarding appropriate cleaning measures.



ADVICE!

The Track Supply is equipped with a standard filter for normal indoor environment. There are finer filters on the market, if required. We recommend the exclusive use of original filter by Rittal. In very challenging/dirty environment we recommend the installation of an air conditioned Track Supply IP54.



ADVICE!

If the operating conditions are challenging and the environment is not clean, Conductix-Wampller recommends shorter intervals of max. 6 months.

For a qualified check of the operating parameters of the system, please contact Conductix-Wampller. Thus you can compare the currently measured values with those obtained during commissioning or the last inspection. Here you can also check free airflow inside the housing and specific torques.



WARNING!

Risk of personal injury of property damage!

Improper attachment of the housing cover can cause severe injuries to persons or damage to components.

- After having completed the maintenance and repair works, close the housing covers again, prior to restarting the system.

Track Supply 6 kW IP54

80 A / 125 A at 400 V / 480 V

18.3 Maintenance Schedule Track Supply IP54 (air-conditioned variant)

The tasks carried out according to the maintenance schedule must be logged. If regular inspections reveal increased wear, the corresponding maintenance intervals should be shortened in accordance with the actual signs of wear. In case of any questions regarding maintenance tasks and intervals, contact the manufacturer; see service address on the last page.



DANGER!

Danger of electric shock!

During maintenance and repair work the Track Supply must be secured against unexpected and unintended switch on.

- Prior to starting maintenance works disconnect the Track Supply from the mains supply!

The following maintenance and inspection works should be carried out every 3 months:

- Visual inspection for external damage and damage due to special ambient conditions (e.g. damage of the housing cover, splash water, oil etc.)
- Inlet and outlet air are free - free airflow must be ensured. Ensure that the airflow and the air ducts are not blocked by any objects. Air conditioning unit must be maintained in accordance with the maintenance instructions of the manufacturer of the air-conditioning unit.
- Ensure that the Track Supply is dry, clean and free from dust and oil. If the Track Supply is very dirty, check the IP-protection and contact Conductix-Wampfler regarding appropriate cleaning measures.



ADVICE!

The Track Supply is equipped with a standard filter for normal indoor environment. If required, you will also find metal filters on the market for ambient conditions with oil-containing air. We recommend the exclusive use of original filters by Rittal.



ADVICE!

If the operating conditions are challenging and the environment is not clean, Conductix-Wampfler recommends shorter intervals of max. 6 months.

For a qualified check of the operating parameters of the system, please contact Conductix-Wampfler. Thus you can compare the currently measured values with those obtained during commissioning or the last inspection. Here you can also check free airflow inside the housing and specific torques.



WARNING!

Risk of personal injury of property damage!

Improper attachment of the housing cover can cause severe injuries to persons or damage to components.

- After having completed the maintenance and repair works, close the housing covers again, prior to restarting the system.

Track Supply 6 kW IP54

80 A / 125 A at 400 V / 480 V

19 Repair

If repair works or the replacement of faulty components are required and possible on site these works have to be carried out by trained personnel or by a Conductix-Wampfler technician, but the relevant safety regulations must be observed. If fault analysis or repair is not possible on site, it is required to send the faulty part to Conductix-Wampfler GmbH. Please contact our service department in this case for further information.

To decide about the procedure we require the following information:

- Product designation
- Material number
- Serial number
- Configuration details (if existing)
- System data (technical and system-specific data)
- Circuit diagram of the system (if available)
- Pictures / photos (if available)
- Description of the fault or the failure scenario
- Presumptions for the failure analysis

General and local safety regulations must be observed. See also chapter 10 „Installation“ and chapter 11 „Warnings and Precautions“.

Track Supply 6 kW IP54

80 A / 125 A at 400 V / 480 V

20 Disassembly and Disposal

20.1 Safety



WARNING!

Danger of injury due to improper disassembly!

Stored residual energies, sharp components, points, and edges on and in the device or the tools needed can cause injury.

- Prior to starting work, ensure that there is sufficient space.
- Handle open, sharp-edges components carefully.
- Maintain order and cleanliness in the work area! Loosely stacked or scattered components and tools are a source of accidents.
- Dismount components properly. Observe the heavy net weight of some components. If required use lifting devices.
- Secure components so that they cannot fall down or tip over.
- Involve the manufacturer in case of any unclear points.



WARNING!

Risk of injury due to insufficient qualification!

Improper use can result in serious injury to persons or property damage.

- All works for installation and commissioning as well as for maintenance and disassembly must be carried out by qualified staff (observe IEC 364 resp. CENELEC HD 384 or DIN VDE 0100 and IEC 664 or DIN VDE 0110 and the national accident prevention regulations).



ADVICE!

Qualified personnel, according to the safety regulations, are persons that are familiar with the installation, assembly, commissioning and operation of energy supply systems and that have the appropriate qualifications.

20.2 Reuse



ADVICE!

If it is necessary to replace the Track Supply due to damage or to install it in another place, verify that no damage can occur during disassembly.



WARNING!

Risk of personal injury of property damage!

Improper use, faulty installation or handling may result in serious personal damage or property damage.

- For installation at another location observe the described mounting and commissioning activities.

Track Supply 6 kW IP54

80 A / 125 A at 400 V / 480 V

20.3 Disassembly

After the system is no longer in use, the device must be disassembled and disposed of in an environmentally friendly way.

1. Disconnect the Track Supply from the mains supply.
2. Wait at least 5 min after having switched off the power supply until the internal storage will be discharged prior to opening the Track Supply.
3. Dismount the Track Supply.
4. Dispose of components specifically → recycling, see chapter 20.4 „Disposal“.

20.4 Disposal

Properly disassembled components are to be recycled if no return or disposal agreement has been made.

- Scrap metals.
- Take plastic elements to recycling.
- The other components are to be disposed of according to their material composition.



CAUTION!

Environmental damage due to improper disposal!

Electrical waste, electronic components, lubricants and other auxiliary materials are subject to hazardous waste disposal regulations and may only be disposed of by authorized specialists.

Local community officials or special disposal companies can provide information about environmentally appropriate disposal.

Track Supply 6 kW IP54

80 A / 125 A at 400 V / 480 V

21 Spare Parts

Only the fuses and a few other components are to be replaced by the operator of the system! All other parts have to be replaced or repaired by trained and qualified Conductix-Wampfler personnel.

21.1 Track Supply Module

Designation	Manufacturer identification	Conductix-Wampfler Mat.-No.	Used quantity	Comment
Fuse 16 A	SIBA gRL (gS) in DO1 cartridge, Part No. 1002734.16	3092096	3	Only for 400 V versions! Only by qualified personnel
Fuse 12 A	Class J fast, 21 x 57 mm, Bussmann JKS-12 Bussmann DFJ-12	3092177	3	Only for 480 V versions! Only by qualified personnel
Control board G4 progr.	91-P600-0210	3087293	1	Only by qualified Conductix-Wampfler personnel!
Display board G4 progr.	91-P600-0233	3087294	1	Only by qualified Conductix-Wampfler personnel!
Spare set fan TS6/16kW front		3189820	1	Only by qualified personnel
Spare set fan TS6/16kW bottom		3189833	1	Only by qualified personnel

Others on request

Track Supply 6 kW IP54

80 A / 125 A at 400 V / 480 V

21.2 Track Supply IP54 Air Cooling

Designation	Manufacturer identification	Conductix-Wampfler Mat.-No.	Used quantity	Comment
Cylindrical fuse Neozed D02 50A 400V GL/GG	Siemens 5SE2350 Alternative type: Fuses of the same installation size and technical data		3	Only for 400 V versions! Only by qualified personnel
Cylindrical fuse Neozed D02 20A 400V GL/GG	Siemens 5SE2320 Alternative type: Fuses of the same installation size and technical data		3	Only for 400 V versions! Only by qualified personnel
Fuse 40 A, 600 VAC Class CD 47.8x21.6 mm	Littelfuse CCMR040 Alternative type: Fuses of the same installation size and technical data		3	Only for 400 V versions! Only by qualified personnel
Fuse 10 A, 600 VAC Class CC 38.1x10.3mm	Littelfuse KLDR010 Alternative type: Fuses of the same installation size and technical data		3	Only for 480 V versions! Only by qualified personnel!
Ventilator	Rittal SK 3244.140		1	Only for variant with ventilator
Filter	Rittal SK3173.100		1	Only for variant with ventilator

Track Supply 6 kW IP54

80 A / 125 A at 400 V / 480 V

21.3 Track Supply IP54 400 V Air-Conditioned

Designation	Manufacturer identification	Conductix-Wampfler Mat.-No.	Used quantity	Comments
Cylindrical fuse Neozed D02 50A 400V GL/GG	Siemens 5SE2350 Alternative type: Fuses of the same installation size and technical data		3	Only for 400 V versions! Only by qualified personnel!
Cylindrical fuse Neozed D02 20A 400V GL/GG	Siemens 5SE2320 Alternative type: Fuses of the same installation size and technical data		3	Only for 400 V versions! Only by qualified personnel!
Fuse 40 A, 600 VAC Class CD 47.8x21.6 mm	Littelfuse CCMR040 Alternative type: Fuses of the same installation size and technical data		3	Only for 480 V versions! Only by qualified personnel!
Fuse 10 A, 600 VAC Class CC 38.1x10.3mm	Littelfuse KLDR010 Alternative type: Fuses of the same installation size and technical data		3	Only for 480 V versions! Only by qualified personnel!
Air conditioning unit	Rittal SK3328.540		1	Only for air-conditioned variant
Filter	Rittal SK3286.400		1	Only for air-conditioned variant

Track Supply 6 kW IP54

80 A / 125 A at 400 V / 480 V

22 Tools

Description	Size / specification	Comments
Hexagon wrench or ring wrench	SW 13	Cable connection (35 mm stranded cable)
Head screw driver	5 - 7 mm	Plug HAN-6HSB earth screw
Head screw driver	3 - 4 mm	Plug HAN-6HSB and HAN-10E
Allen key	3 mm	To open the Track Supply
Insulation stripping tool	-	-
Side Cutter	-	-
Screwdriver set		

Housing: For tools and further details see notes of RITTAL GmbH & Co. KG.

Air conditioning unit: For tools and further details see notes of RITTAL GmbH & Co. KG.

For commissioning you require further tools, a laptop with configuration software and a measuring device.

Conductix-Wampfler GmbH
Rheinstraße 27 + 33
79576 Weil am Rhein - Markt
Germany

Phone: +49 (0) 7621 662-0
Fax: +49 (0) 7621 662-144
info.de@conductix.com
www.conductix.com



Importer for the United Kingdom:
Conductix-Wampfler Ltd.
1, Michigan Avenue
Salford
M50 2GY
United Kingdom

Phone: +44 161 8480161
Fax: +44 161 8737017
info.uk@conductix.com
www.conductix.com