

Regulator

4 kW 560 V DC 40% Duty Cycle + 24 V DC

Order-Number

91012-411-3090871: 4 kW Regulator 560 V DC 40% Duty Cycle + 24 V DC, EMS

91012-411-3090872: 4 kW Regulator 560 V DC 40% Duty Cycle + 24 V DC, AIR

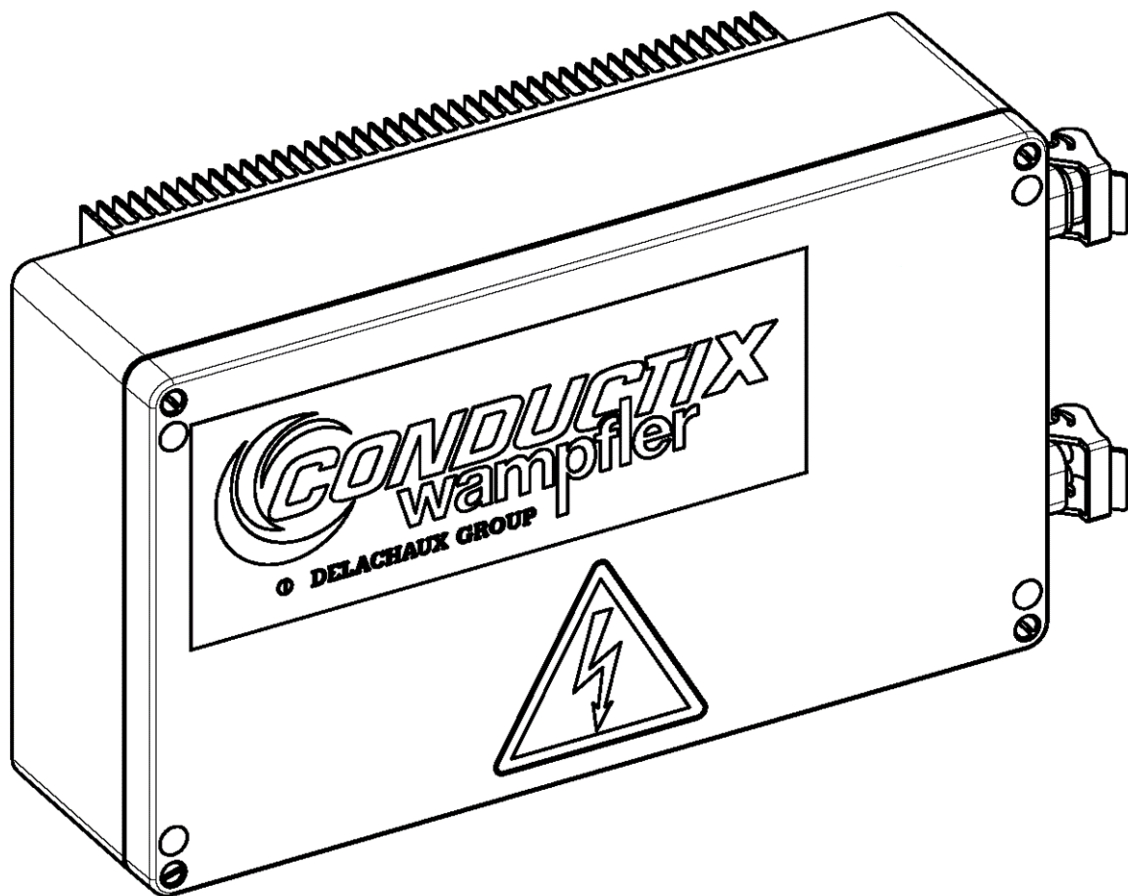

Regulator

4 kW 560 V DC 40% Duty Cycle + 24 V DC

Contents

1	Symbols and Hints	4
2	Advisory Information for the User	5
3	Intended Purpose.....	5
4	Technical Data	6
4.1	Electrical Data	6
4.2	Environmental Data	7
4.3	Protection Measures.....	8
4.4	Mechanical Integration	8
4.5	Electrical Connections	10
4.5.1	Connection of Power Input: X1	10
4.5.2	Connection of Power Outputs: X2	10
4.5.3	Connection of Interface: X3	11
4.5.4	Ground Connection	11
4.5.5	ESD Protection	11
5	Scope of Delivery.....	12
6	Transport and Storage	12
7	Installation	12
7.1	Who is Authorized to Carry out the Installation	12
7.2	General Advice for the Installation.....	12
7.3	Electrical Regulations	13
7.4	Recommended Connection	13
7.4.1	Connection of Pilot Pins	13
7.4.2	Example: Using the Interface	14
7.4.3	Example: Interface is not used	15
7.5	Place and Conditions of Installation	16
7.5.1	Position	16
7.5.2	Air Flow Required	16
7.5.3	Proximity to Iron/Steel	17
7.5.4	Attachment Points	17
8	Operation	18
8.1	Powering Up	18

Regulator

4 kW 560 V DC 40% Duty Cycle + 24 V DC

8.2	Powering Down	18
8.3	Positional Tolerances	19
8.4	Parallel Operation of Regulators	19
8.5	Maximum Number of Regulators on a Track.....	19
8.6	Information on Operation with Interface	20
8.7	Precautions.....	20
9	Warnings and Cautions.....	21
10	Fault and Diagnosis	22
10.1	Basics	22
10.2	Normal State.....	23
10.3	Signals and Meanings	24
10.4	Reset	26
11	Maintenance	27
12	Repair	27
13	Disassembly and Re-use	28
13.1	Safety Advice for Disassembly and Disposal	28
13.2	Recycling	28
14	Accessories.....	29
14.1	Power Input X1	29
14.2	Power Output X2	29
14.3	Interface.....	30
15	Tools	31

This Operation Manual is based on the following Documentation-No.: OM9100-0126c-EN!

Important:

This manual refers solely the appliance described. See the system description document for information about the complete system and the interaction between components.

Company names mentioned in this manual that are registered and protected trade names by copyright remain the property of the companies themselves. In order to improve the energy supply system and its function, we reserve the right to carry out technical modifications of illustrations and statements in this operation manual.

Please find details related to a whole system in the system manuals. Always refer to the system documentation before starting any work on the system or components within the system or before operating the system.

Reprint and duplication (even partially) are only allowed with permission from Conductix-Wampfler.

© Conductix-Wampfler GmbH 2016

Regulator

4 kW 560 V DC 40% Duty Cycle + 24 V DC

1 Symbols and Hints



Warning of voltage

This symbol can be found in several places of the operation manual, where special care has to be taken due to voltage presence which is a potential danger to the life of people. Please observe these instructions and be careful in those cases. Please carry out all health and safety regulations to other users as well.

Always disconnect the system from the main supply before working on the energy supply system.



Attention – some hints

This sign draws the attention to parts of the operation manual, where the regulations, advice and correct operational sequence must be observed to avoid any damage or destruction to the energy supply system and its components.



Temperature

This sign draws the attention to parts of the operation manual, where special care must be taken on account of heating of surfaces or on account of inductive heating of ferromagnetic material and where other special measures have to be taken.

Please pass on the corresponding advice to other users too.

To achieve fault-free operation and any rights to claim guarantee it is necessary to observe and fulfill the information given in this manual or related documents at any time. Read the manual entirely before starting any work and operation of the device.

This manual contains operation related information. It is therefore recommendable to keep it in the vicinity of the device.

Regulator

4 kW 560 V DC 40% Duty Cycle + 24 V DC

2 Advisory Information for the User



This device contains life threatening voltages. Improper handling/operation or faulty installation can result in electric shocks and/or burns as well as material damages. There are no user serviceable parts in the device. Do not open, do not insert any objects inside.



All electric installation and commissioning work as well as repair work and disassembly have to be carried out by qualified staff (IEC 364 respectively CENELEC HD 384 or DIN VDE 0100 and IEC 664 or DIN VDE 0110 and national safety rules).



Qualified staff according to the safety regulations are persons that are familiar with the installation, assembly, commissioning and operation of the energy supply system and that have the appropriate qualifications.

Conductix-Wampfler GmbH cannot be responsible for damage and breakdown that have been caused by not observing this manual.

This manual contains exclusively details of the specified device.

Observe all instructions and technical data given in this manual. Ensure that the device is operated under the specified conditions only.

Do not start up the device or related devices within the system until you have made sure that the machine/system it is integrated into complies with the applicable norms, standards and directives and that conformity is stated.

We reserve the right to carry out technical modifications of illustrations and statements in this instruction manual. References to other documents specifying the document number do not include the revision index. Refer to the project handbook when available for a list of relevant documents.

Unless specified differently, all data refer to the metric system, i.e. lengths are always in millimeter. Units used are based on European standards.

3 Intended Purpose

The intended purpose of this device is for use in conjunction with other components for the inductive transfer of electrical power. A Regulator produces DC voltage from the AC magnetic field generated by an track and captured by a Pickup. The environment of a Pickup defines which version of Regulator is suitable for order (see also chapter 7.5.3):

- electro-monorail systems (EMS) or similar installation where Pickups will evolve in close proximity to aluminum → EMS version
- all other applications where Pickups do not come in close proximity with any metallic parts → AIR version

The device is not suitable for standalone operation and must be used in conjunction with the appropriate components. Qualified personnel only may operate this equipment.

Regulator

4 kW 560 V DC 40% Duty Cycle + 24 V DC

4 Technical Data



The data specified in this section are valid only if the requirements regarding the environment of the device (position, ambient temperature etc...) are respected.



For instance, the layout of the track, the variations with respect to nominal position of a Pickup, or the ambient temperature around a Regulator, may lead to a reduction of the peak and/or continuous power available.



Regulators and Pickups are not designed for independent operation. Refer to both operation manuals together.

4.1 Electrical Data

- Input 4 kW Pickup, 20 kHz (see chapter 14.1)
- Output voltage 1 560 V DC +/-25 V AC
- Output current 1 8 A DC maximum
- Peak output power 4 kW
in sum for both output 1+ 2 and under adequate condition of operation (see chapter 7.5 and chapter 8.3).
- Continuous output power 1,6 kW at 40°C ambient = 40% duty cycle
2,5 kW at 20°C ambient
over 10 minute periods, air convection 0,1 m/s and nominal position (see chapter 7.5).
in sum for both output 1 and 2
- Output 2 24 V DC +/-5%
5 A DC
based on the output voltage 1 (see chapter 10.2 and chapter 10.3)
do not overload
maximal short-circuit current: 11 A DC
- Heat loss Approximately 400 W at full load.
- Electrical protection Class II (reinforced internal insulation)
- Insulation Output 1 to Ground / Output 2 / Interface: production tested at 5 kV DC / 5 s.
Output 2 / Interface to Ground tested at 500 V DC / 5 s.

Regulator

4 kW 560 V DC 40% Duty Cycle + 24 V DC

4.2 Environmental Data

- Storage temperature -20°C to +60°C
- Transport temperature -40°C to +80°C
- Ambient temperature +0°C to +40°C
Air temperature as measured in immediate vicinity of working device. Please note that the heat loss of the Regulator will raise the ambient temperature, especially in enclosed mounting spaces.
- Operation For indoor operation only.
- Humidity < 95%, non-condensing
- Chemical resistance For industrial use without special conditions.
Any specific influences of chemicals must be checked.
- Protection rating IP54 when plugs are in place
- EMC environment The device is designed for use in industrial environments (EN55011 Class A)
- Installation altitude Up to 1000 m; continuous output power must be de-rated for higher altitudes

The use in explosion-proof areas or in areas where the device is exposed to harmful oils, acids, vapors, dust, gases, radiation, humidity etc. is explicitly forbidden.

Regulator

4 kW 560 V DC 40% Duty Cycle + 24 V DC

4.3 Protection Measures

The Regulator is protected against the following events:

- Over voltage Automatic shutdown if the voltage supplied by the Regulator exceeds 610 V.
Output protected up to 850 V (no reverse polarization)
- Disconnected DC output Automatic shutdown when unplugged/disconnected:
Protection against DC contact arcing; output voltage is removed.
Unplugging under load is not recommended
(proper wiring of the pilot pins: see chapter 7.4).
- Over current Output 1 is current limited
Automatic shutdown on strong overload or short circuit of output 1 - i.e. voltage < 100 V.
A high transient over current i.e. a sudden short circuit will damage the device.
- Reverse current Output 1 is protected against reverse current flow -
but not protected against reversed polarization i.e. reverse battery connection.
- Over temperature Automatic shutdown on internal over temperature
i.e. as a consequence if maximum rated temperature and/or maximum continuous
output power are exceeded.
- Repetitive shutdowns Shutdown procedures (i.e. turning off the Regulator through the interface plug)
discharge the energy stored inside the Regulator. To avoid overheating, the number of
shutdown procedures is limited to 3 within 30 seconds. This number exceeded, the
Regulator will remain in disable mode and respond only passed a delay of 30 seconds.

4.4 Mechanical Integration

- Dimensions See drawing
Versions 91012-411-3090871 and 91012-411-3090872 are mechanically identical.
- Weight 10 kg (without cables or Pickup)
- Surface temperatures Heatsink surface temperature may reach up to 70°C depending on operating conditions
To a lesser extent the housing may also get hot.

Regulator

4 kW 560 V DC 40% Duty Cycle + 24 V DC

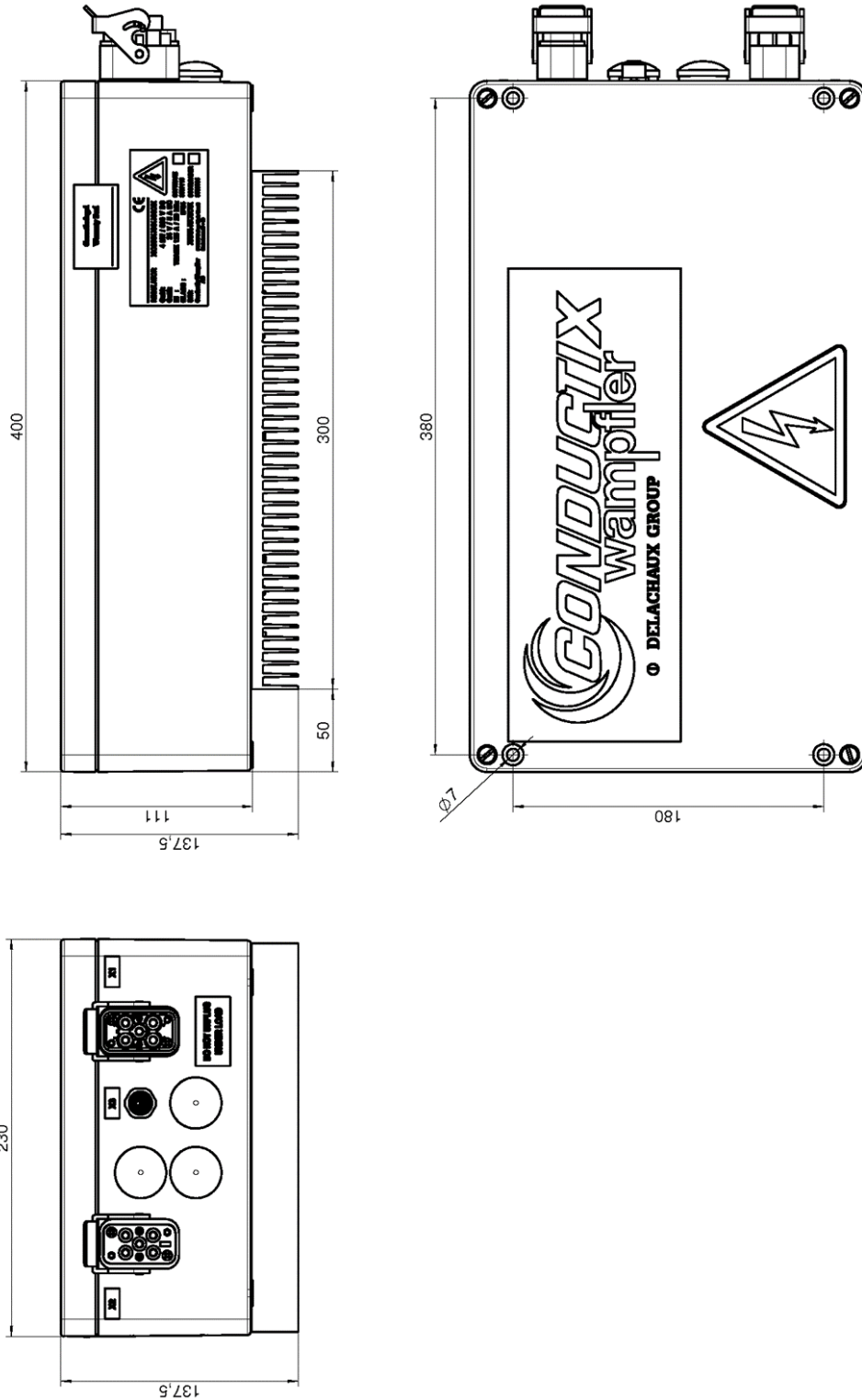

Regulator

4 kW 560 V DC 40% Duty Cycle + 24 V DC

4.5 Electrical Connections

- X1 - AC Input Refer to chapter 14 for information on Pickups
- X2 - DC Power outputs HAN Q4/2 (Harting) or CQM04/2 (Ilme)
- X3 - Interface SACC-E-M12FS-8CON (Phoenix) or series 763/8-pole (Binder)

Connection cables can be ordered separately. Refer to chapter 14.

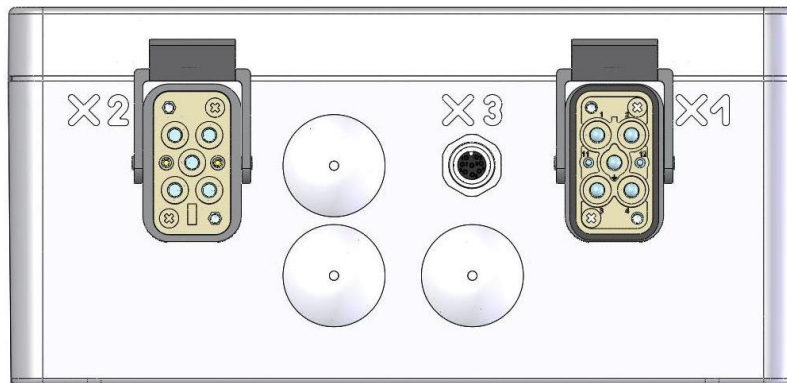

4.5.1 Connection of Power Input: X1

The power input of the Regulator must be connected to a suitable Pickup. The use of an extension cable between the Regulator and the Pickup is generally not allowed. Refer to paragraph 14 for information on Pickups.

4.5.2 Connection of Power Outputs: X2

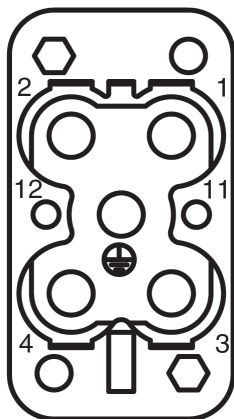

(view: contact side)

- | | |
|--|--|
| PIN 1 | > DC+ out |
| PIN 3 | > DC- out |
| <i>(Power output 560 V DC)</i> | |
| PIN 2 | > 24 V DC |
| PIN 4 | > 0 V DC |
| <i>(Isolated 24 V / 5 A DC power output)</i> | |
| <i>this 24V/5A output is different from the 24V/150mA available on the interface plug X3</i> | |
| PIN 11 | > Pilot 1 |
| PIN 12 | > Pilot 2 |
| <i>(Pilot 1 and 2 must be shorted for the device to power up – see chapter 7.4, 8.1 and 8.2)</i> | |
| PIN |  > Ground |

Regulator

4 kW 560 V DC 40% Duty Cycle + 24 V DC

4.5.3 Connection of Interface: X3

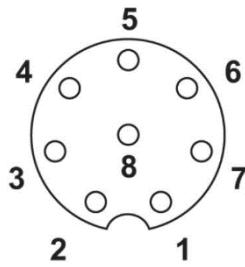

(view: contact side)

PIN 1 > Isolated 24 VDC

PIN 2 > Isolated 0VDC

*(150mA maximum. Do not distribute externally: see chapter 8.1 and 8.2).
this internal 24V/150mA is different from the 24V/5A output available on X2*

PIN 3 > COM

(common to the 3 output relays "Warning", "Error" and "Status")

PIN 4 > Enable

(must be connected to allow the Regulator to power up. See chapter 8.1 and 8.2.)

PIN 5 > Warning

PIN 6 > Error

PIN 7 > Status

(relays have potential free contacts, rated for 30 V DC / 5 A max.)

PIN 8 > Ground

All pins are isolated from the main power output.

4.5.4 Ground Connection

All electrical equipment must be connected together to the vehicle frame to ensure an equipotential bonding. The ground output of each plug must therefore be connected. In the same way, make sure to connect the housing of the device to the vehicle frame (GND) and not rely only on the connection to ground provided by the power connector. The reason is that if the connection to the load is removed while the primary is active, then the device is still internally energized though the ground connection is broken.

4.5.5 ESD Protection

Because the system is isolated, some electrical charges may accumulate on the vehicle depending on the surrounding conditions and the vehicle design. An adequate solution must be foreseen using a conductive floor coating together with for example conductive brushes, sliders, track rollers, wheels or similar methods for a connection to Earth, in order to reduce the likelihood of static charge build up and therefore ensure protection against electrostatic discharge (ESD).

Regulator

4 kW 560 V DC 40% Duty Cycle + 24 V DC

5 Scope of Delivery

Cables and plugs, as well as material for mounting the device to a supporting structure (i.e. screws etc.) are not included in the scope of supply. Refer to chapter 14 for more information.

6 Transport and Storage



WARNING!

The transport company must be advised about any damage that has been detected after delivery. Prior to installing or starting operation with damaged components please consult the supplier.

Refer to chapter 4 for required transport and storage conditions.

7 Installation

7.1 Who is Authorized to Carry out the Installation



All installation and commissioning work as well as maintenance work and disassembly have to be carried out by qualified staff (IEC 364 respectively CENELEC HD 384 or DIN VDE 0100 and IEC 664 or DIN VDE 0110 and national safety rules).



Qualified staff according to the safety regulations are persons who are familiar with the assembly and installation of the energy supply system and who have the appropriate qualifications.

7.2 General Advice for the Installation



WARNING!

After receipt of the components, and prior to starting the installation work:

- Unpack the components and check carefully for damage that may have occurred during transport or storage (damage to housings and insulation, missing parts etc.).
- Check data on the identification plate to make sure that the components meet the requirements with regard to nominal power and voltage and that they are matching parts to the Pickup used.
- Check completeness of the documents and conformity with the delivered components.

Regulator

4 kW 560 V DC 40% Duty Cycle + 24 V DC

Regulators have to be installed on an even surface and in a permanently safe position. An improper installation of the energy supply system has a negative impact on the function, the efficiency and the lifetime of the device. It is therefore important to observe the specification for the choice and place of installation. The warranty will expire if this is not observed!

Follow the instructions of chapter 7.5 for attaching a Regulator to a supporting structure. See also chapter 4.5.4 for making the connection to ground.

7.3 Electrical Regulations



WARNING!

The general electrical operating conditions according to VDE 0100 (installation and operation of electrical equipment up to 1000 V) have to be observed. If necessary apply the local regulations when they go beyond or differ from these requirements.

7.4 Recommended Connection

7.4.1 Connection of Pilot Pins

Shorter pilot pins are used in the power connector (Regulator side) to provide a signal to the Regulator when the load is connected. Breaking the pilot connection while unplugging will signal to the Regulator to shut down before the main contacts are disconnected, thus preventing DC arcing in the connectors (protection measure presented in chapter 4.3).

If the pilot signal is shorted in the plug on the Regulator side, the Regulator will not be able to detect when the cable is disconnected at the load side. No protection against DC contact arcing can be expected in this case, nor would the output voltage be disabled once the cable disconnected. This could result in an unsafe situation.

In order to fully use the benefits of the pilot pins in case the power output cable is disconnected, we recommend shorting the pilot pins on the load side. Only this way is it assured that the Regulator switches off when the cable is disconnected, be it on the Regulator side as well as on the load side. Refer to following examples for more details.

Regulator

4 kW 560 V DC 40% Duty Cycle + 24 V DC

7.4.2 Example: Using the Interface

Below is an example of connection when both the power output and the interface connection are used.

The interface connection allows turning on and off the Regulator even under load and provides as well an easy way to reset the device in case a fault has been detected. These basic functions are fulfilled by the switch connected between pins 1 and 4 on the vehicle side. Due to the low voltages involved and the isolated characteristics of the interface connections, the switch requires very basic isolation and ratings (24 V DC / 150 mA).

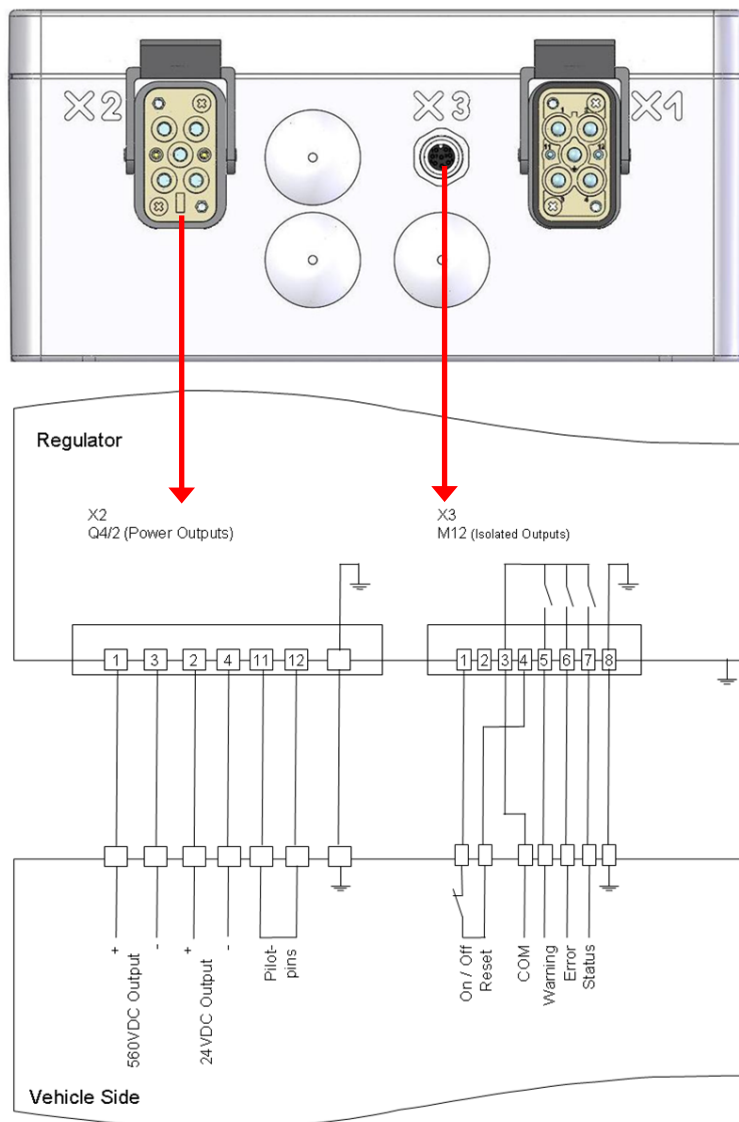

Initial status of relays, please see chapter 10.

Regulator

4 kW 560 V DC 40% Duty Cycle + 24 V DC

7.4.3 Example: Interface is not used

Even if signals available through the interface plug are not being used, it is still **necessary to connect pin 1 to pin 4 for the Regulator to start**. See also chapter 8.1 for more information on this subject.

Pilot pins are not designed to be used as an ON/OFF switch and it is thus recommended not to open the pilot connection under load. However, disconnecting the pilot pins will reset the Regulator. Therefore, this procedure can be used to reset a fault in case of automatic shutdown. This is the purpose of the switch shown in the following illustration, connecting pins 11 and 12 on the load side. Refer to chapter 0 for more information.

Voltage present on the pilot pins is not isolated from the main output power. Make sure to use a switch with suitable isolation to ground. Rating between contacts is 24 V DC / 150mA.

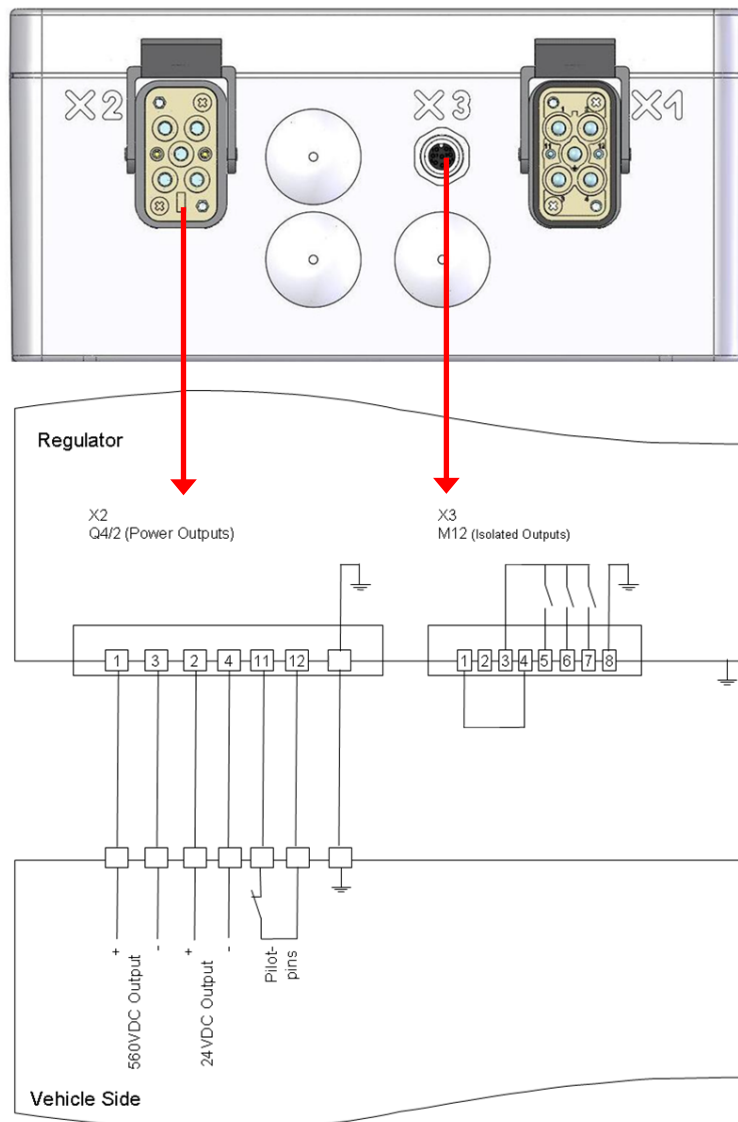

Initial status of relays, please see chapter 10.

Regulator

4 kW 560 V DC 40% Duty Cycle + 24 V DC

7.5 Place and Conditions of Installation



WARNING!

Install the Regulator in an environment and under conditions as specified in this document only. The Regulator is to be attached to a solid base, mounted with the heatsink fins in a vertical position.

Ensure free space around Regulator to provide sufficient cooling air circulation.

The available output power as specified in this document strongly depends on the ambient conditions of the device. Refer to chapter 4.1 for more information.

7.5.1 Position



WARNING!

A vertical position of the heatsink cooling fins is required to maximize the efficiency of convection cooling. If the Regulator is positioned differently, the maximum continuous power available may be reduced.

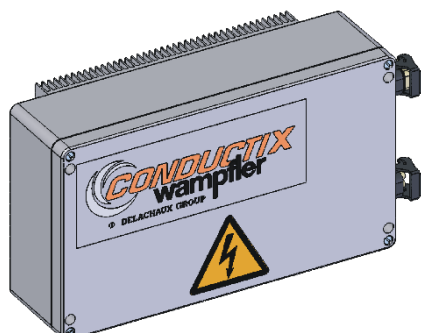

7.5.2 Air Flow Required

The heat power of the Regulator is dissipated by convection and radiated cooling only. Ensure that free flow of air is guaranteed around the device at all times. It is essential to make sure that the air flow is not hindered in any way by objects and that the device is protected from additional heating, i.e. exposure to sun light or hot air flow from inverters, proximity to brake resistors.



Confined areas should be adequately ventilated, allowing also for the heat generated by the Regulator which can reach about 400 W under full load conditions.



Positions where free air flow around the device and more specifically around the heatsink is not sufficiently provided, i.e. close or directly against an obstacle, will lead to higher local temperature and therefore cannot be allowed generally.

Failure to satisfy these requirements may result in reduced performance, damage and/or reduction in lifetime.

Regulator

4 kW 560 V DC 40% Duty Cycle + 24 V DC

7.5.3 Proximity to Iron/Steel

There are no special requirements regarding the proximity of the Regulator itself to ferromagnetic material. However special care should be taken regarding the presence of ferromagnetic material near the Pickup (refer to chapter 14.1 for more information) and near the track itself (Refer to the entire documentations related to the installation of your system).

We strongly recommend to respect the specifications for areas free of ferromagnetic material as specified in the document mentioned above, and even to go beyond these requirements whenever possible.

7.5.4 Attachment Points

Attaching a Regulator to a supporting structure must be done without opening the lid. For that purpose, four holes are accessible from the top of the device.

Warranty seals are placed on the housing in order to forbid the opening of the lid and therefore preventing accidental soiling or insertion of foreign parts. Breaking a seal will terminate the warranty.

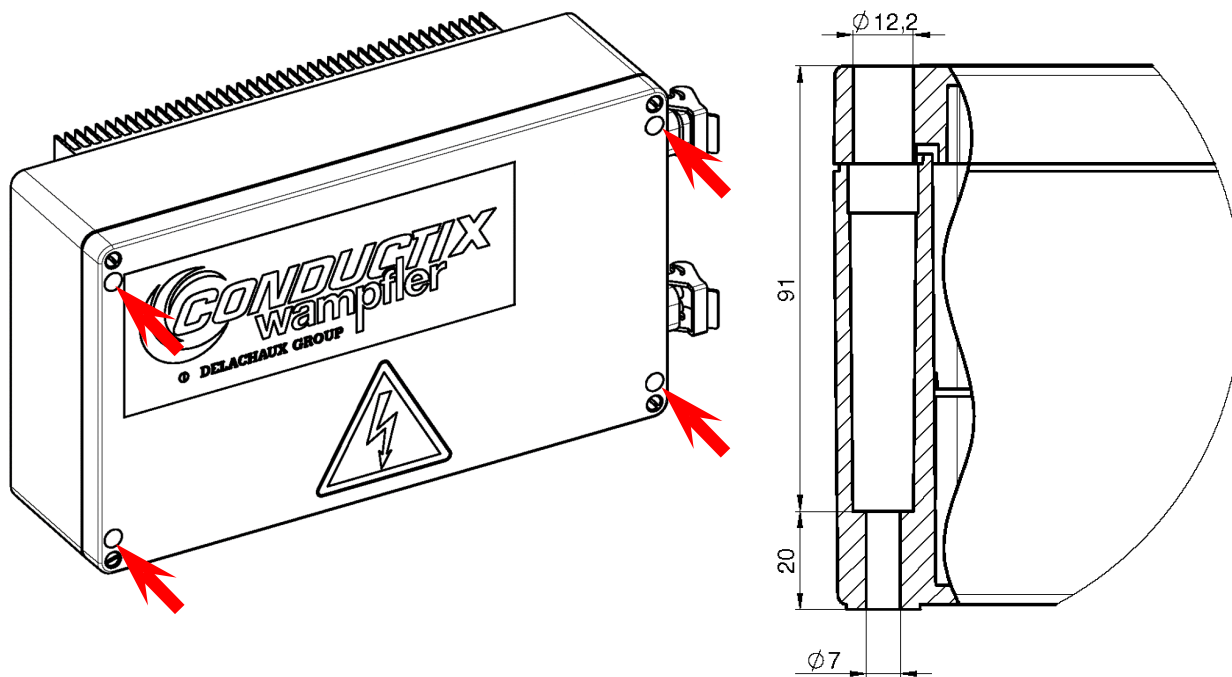

Regulator

4 kW 560 V DC 40% Duty Cycle + 24 V DC

8 Operation

8.1 Powering Up

The primary track being switched on, once a suitable magnetic field is detected, and if the pilot pins (pins 11 and 12 of the power output connector) are shorted, the Regulator will be ready to be switched on. The output voltage will however appear at the power output of the shrouded pin connector only if the Regulator is enabled at the interface plug. Enabling the Regulator can be done in two different ways:

- by making a connection between pin 1 (internal isolated 24 V) and pin 4 (enable),
- by connecting an external 24 V supply. 0V to pin 2 and 24V to pin 4.

Note that when the Regulator is in the disable mode (pin 1 and 4 disconnected), the internal isolated 24 V supply is only suitable to supply a starting signal to the Regulator itself; do not distribute externally! When the Regulator is enabled and the "status" relay is closed (between pins 3 and 7), the maximum current allowed is 150 mA.

⇒ **When the interface is not used:**

Even if signals available through the interface plug are not being used, it is still **necessary to connect pin 1 to pin 4 for the Regulator to start.**

An optional "enable plug" is available for that matter, see chapter 14.3.

8.2 Powering Down

Turning off the primary track will immediately turn off all Regulators present on the track unless they are enabled. If a Regulator is in an enable mode, the output voltage will decrease according to the load connected to it. This behavior allows continued function (the length in time depends on the load needed at that point) even in the case where the power is temporarily interrupted (i.e. the Track Supply was briefly turned off, a Pickup runs over an area where the magnetic field from the track is shielded... etc.)

Turning off a Regulator resets the error mode. It may therefore be required in the event of a fault to turn off a single Regulator, instead of turning the track supply which would turn off all vehicles. Please, refer to chapter 10.4 to find out more on how to reset Regulators.

If the need of turning on and off a Regulator exists even under load, using the interface plug is the best way to proceed; simply break the contact with pin 4. It is not recommended to use the pilot pins to turn off a Regulator under load.

When a Regulator is turned off, the energy stored internally is discharged to reduce the output voltage to a minimum. For this reason, the number of times a Regulator can be turned off (number of shutdown procedures) is limited to 3 within 30 seconds. Exceeding this limit causes the Regulator not to respond and it will remain disabled (off) for the next 30 seconds.

Regulator

4 kW 560 V DC 40% Duty Cycle + 24 V DC

8.3 Positional Tolerances

The data concerning Regulators specified in this documentation strongly depend on the interaction with the attached Pickup. The validity of these specifications depends on the respect of nominal positions as defined for the Pickup itself. Always refer to both the operating instructions of a Regulator and of its designated Pickup.

The power ratings - peak power as well as continuous power - of the combination Pickup and Regulator will be affected by the relative position of the Pickup to the Track and therefore the layout of the track, i.e. bifurcations, curves, influence of ferromagnetic material, etc. See also chapter 7.5.

8.4 Parallel Operation of Regulators

Up to five Regulators can be connected together in parallel (more upon request). By parallel operation it is understood that only the main voltage output X2 of several Regulators are connected together (exception made of the ground connection see chapter 4.5.4). In other words, connections with pins 2, 4, 11 and 12 of X2, as well as all connections with X3 must remain separate for each Regulator.



WARNING!

When several Regulators are directly connected to a common bus, voltage will be present if a plug is disconnected on the Regulator side. Please note that the interface makes it possible to detect when a power plug is disconnected while other Regulators are still powered up, see below.

⇒ When the interface is used:

Due to their isolated properties, it is possible to interconnect the M12 interfaces together. However, we recommend to wire each signal separately to determine precisely which signal comes from which Regulator and therefore to be able to take corresponding action independently (i.e. if a Regulator entered an error mode, it can be reset without having to completely stop the vehicle). As mentioned above, the detection of a disconnected power plug is possible. A closed "Warning" relay and open "Status" relay, while the controls of the vehicle still provide an "enable" (or ON) signal, is characteristic of such a case and therefore of a possibly unsafe situation if other Regulators are still powered up.

8.5 Maximum Number of Regulators on a Track



WARNING!

When the primary track is first turned on, Regulators shortly draw a certain amount of energy, energy which is proportional to the number of Regulators (enabled) present on the Track during start-up. In the same way, the peak power and continuous power required during operation are determining factors of the maximum number of Regulators allowed on a Track. Make sure that the Track Supply specifications and the maximum number of Regulators possibly present on this primary Track are compatible.

This parameter is defined during project planning by Conductix-Wampfler and may be critical for the reliability of the whole system. Therefore, the extension or the modification of an existing system is only allowed upon acceptance of the new parameters by Conductix-Wampfler.

Regulator

4 kW 560 V DC 40% Duty Cycle + 24 V DC

8.6 Information on Operation with Interface

The signals that are available through the M12 interface plug are described hereafter, including their initial state (open or closed). For more details on available information and diagnosis see chapter 0.

- Error relay (pins 3 - 6)

Closes when a magnetic field acceptable to ensure the minimum function is detected and when no error occurs. This is however no guarantee for the deliverable output power (refer to chapter 7.5). Opens when an error is detected.

- Warning relay (pins 3 - 5)

Is normally open. Closes when approaching limits of operations (i.e. temperature, overload) to give the user the opportunity to take the signal into account and prevent an automatic shutdown which could cause the vehicle to stop in a critical zone and/or at a critical moment. Provides also some information on the status of the pilot pin function. See also chapter 8.4.

- Status relay (pins 3 - 7)

Is normally open. Closes when the main output has been enabled and the regulation functions are fully ready for operation with load. The state of this relay is no guaranty for the accuracy of the voltage output i.e. in case of overload the voltage will be lower than the nominal value specified.

8.7 Precautions



Regulators are not designed for independent operation. They have to be operated in conjunction with corresponding Rail components.



Never operate a device showing damage or that is in a non-touch proof state. Do not perform any work on the device while in operation. Life threatening danger of electrical shock!



During or after operation surfaces of the Regulator may be hot. Use caution! Prevent access to hot surfaces if necessary. Refer to chapter 4.4 for more information.

Never short circuit the power output 1 or discharge it into a resistance of less than 20 ohms.

Do not overload the power output 2.

These may result in high discharge currents and therefore severe damage may occur.

Do not connect or switch a charged or powered Regulator directly on to any batteries. Connection should only take place when the Regulator is in a powered down state. Never connect a battery load in reverse polarity, damage will occur. Regulators will draw a small amount of power from batteries even if switched off; batteries will discharge.

Ensure adequate ventilation. Refer to chapter 7.5.

Regulator

4 kW 560 V DC 40% Duty Cycle + 24 V DC

9 Warnings and Cautions



All electric work has to be carried out by qualified staff (IEC 364 respectively ENELEC HD 384 or DIN VDE 0100 and IEC 664 or DIN VDE 0110 and national safety rules).

Qualified staff, according to safety regulations, are persons that are familiar with the installation, commissioning and operation of the energy supply systems and that have the appropriate qualifications.



The device is only foreseen to be operated in conjunction with matching components. If you are not sure whether components match, contact Conductix-Wampfler. Do not put into operation before.



Do not install an obviously damaged device. Do not take damaged devices into operation. Severe damage may result. Ensure that protection device and other preventive measures taken comply with the applicable regulations. Make sure that all connected circuits fulfill requirements for safe operation. Make sure that the device cannot start up unintentionally.

Route power and control cables separately so that no interference can occur. Only use cables with a cross-section suitable for the given currents. Note polarity when connecting any device to the output of the Regulators. If not observed, severe damage may result.

During or after operation surfaces of the Regulators and components nearby may be hot. Use caution! Prevent access to hot surfaces if necessary.

Regulators can contain voltage even in a disabled mode (OFF), even if status LED's have gone out. Do not open, do not insert any objects inside, do not touch connection terminals. The only safe means of working on circuits connected to the device is to ensure that the primary track is switched off and then to disconnect physically the input and output plugs. Make sure that connections are not removed under dangerous conditions, i.e. under load. Allow at least 5 minutes before touching connection terminals to be sure that no energy remains stored internally by capacitors. Improper handling can result in electric shocks or burns as well as damage to the Regulator.

Do not perform any work on or around the device while in operation. **Life threatening danger of electrical shock!**

Regulator

4 kW 560 V DC 40% Duty Cycle + 24 V DC

10 Fault and Diagnosis

10.1 Basics

White LED: auxiliary power output 24 V / 5 A DC ○

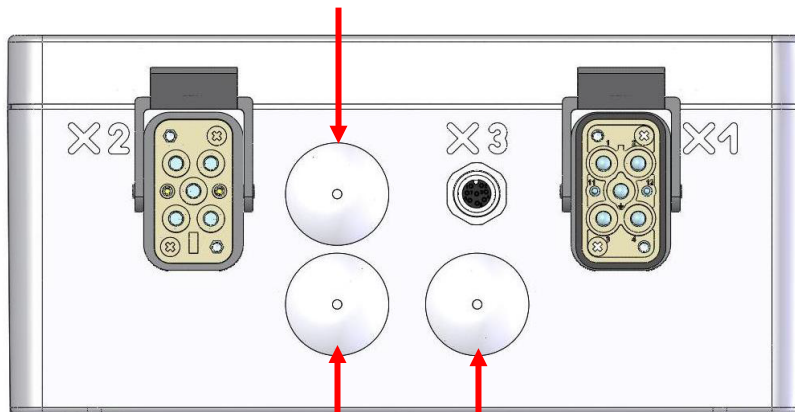

orange LED: "warning" ●

● green LED: "status"
● red LED: "error"

Information is provided by four different colors:

(white): auxiliary power output 24 V / 5 A DC ○

(red): "error" LED or (green): "status" LED ● ●

(orange): "warning" LED ●

The interface plug provides 3 potential free relays with a common pin (pin 3).

For more information on relays, see also chapter 8.6.

- "Error" relay (pins 3 - 6)
Open when primary power absent or in error state. Closed under normal conditions.
- "Warning" relay (pins 3 - 5)
Initially open. Closed only to signal a warning.
- "Status" relay (pins 3 - 7)
Initially open. Closed once the Regulator is enabled and ready for operation with load.

The state of operation of a Regulator can be determined precisely using the LED display and the interface plug shown above. Relays and LED's provide the same information though LED's may display additional information by remaining on or blinking.



WARNING!

Do not install an obviously damaged device. Do not take damaged devices into operation. Severe damage may result. Ensure that protection device and other preventive measures taken comply with the applicable regulations. Make sure that all connected circuits fulfill requirements for safe operation. Make sure that the device cannot start up unintentionally.

Regulator

4 kW 560 V DC 40% Duty Cycle + 24 V DC

10.2 Normal State

When a Regulator is **disabled** (primary track is on but Regulator turned OFF) the following information is available:

- (white): "24 V" LED off *
- (red): "Error" LED off + "error" relay (pins 3 - 6) closed
- (orange): "Warning" LED off + "warning" relay (pins 3 - 5) open **
- ☀ (green): "Status" LED **blinking** + "status" relay (pins 3 - 7) **open**

When a Regulator is **enabled** (primary track is on and Regulator turned ON) and working under normal conditions of operation as specified in this documentation, the following information is available:

- (white): "24 V" LED on *
- (red): "Error" LED off + "error" relay (pins 3 - 6) closed
- (orange): "Warning" LED off + "warning" relay (pins 3 - 5) open**
- (green): "Status" LED **on** + "status" relay (pins 3 - 7) **closed**

* note: the auxiliary 24 V / 5A DC (output 2) is provided through the voltage output 1 (though isolated), therefore it is available only if the voltage output 1 is enabled. Typically, this corresponds to about 1 second after the enable signal is provided or at least to less than 1 second once the green LED remains ON, once the "status" relay closes.

** note: A closed "warning" relay while the orange LED remains on does not necessarily indicate that the Regulator is being operated under abnormal conditions; it may be that the Regulator operates in conditions close to its limits while still within its specifications. Refer to paragraph 10.3 for more information about possible meanings of warning signals.

Regulator

4 kW 560 V DC 40% Duty Cycle + 24 V DC

10.3 Signals and Meanings

Warning signals provide detailed information according to how they are displayed (LED blinking or not) and in which context (which state for other LED's/Relays). Refer to table 1 for information based on relay states and to table 2 when based on LED display.

Note that if the primary track supply is not on or if the Regulator is not correctly positioned over the primary track cable, all the LED's are off and all the relays are open:

- (white): "24 V" LED off
- (red): "Error" LED off + "error" relay (pins 3 - 6) open
- (orange): "Warning" LED off + "warning" relay (pins 3 - 5) open
- (green): "Status" LED off + "status" relay (pins 3 - 7) open

If the above situation happens (all LED's off + all relays open) despite the fact that the primary track is on and that the Pickup is adequately positioned, then the Regulator or the Pickup is out of order.



WARNING!

Do not install an obviously damaged device. Do not take damaged devices into operation. Severe damage may result. Ensure that protection device and other preventive measures taken comply with the applicable regulations. Make sure that all connected circuits fulfill requirements for safe operation. Make sure that the device cannot start up unintentionally.

Regulator

4 kW 560 V DC 40% Duty Cycle + 24 V DC

	status relay closed	status relay open	error relay open
warning relay is closed	see a) or b)	see c)	see d)
warning relay is open	normal operation: see chapter 10.2	normal operation: see chapter 10.2	see e)

Table 1: Relay outputs and meaning













	 green LED remains ON (Status relay closed)	 green LED is blinking (Status relay open)	 red LED remains ON (Error relay open)
orange LED remains ON  (warning relay closed)	see a)		
orange LED is blinking  (warning relay closed)	see b)	see c)	see d)
orange LED is OFF  (warning relay open)	normal operation: see chapter 10.2	normal operation: see chapter 10.2	see e)
white LED remains ON  (no relay relevant)	normal operation: see chapter 10.2		
white LED is OFF  (warning relay open)	see f)	normal operation: see chapter 10.2	see e)

Table 2: LED display and meaning

- The maximum peak power available is exceeded. Refer to chapter 4.1 "Electrical Data", 7.5 "Place and Conditions of Installation" and 8.3 "Positional Tolerances" to make sure the requirements in peak power match the actual conditions of operation.
- The internal temperature is approaching maximum ratings. If the continuous power consumed is compatible with the specified technical data (chapter 4.1 and 4.2) and together in accordance with chapter 7.5 "Place and Conditions of Installation", this warning will have no consequence and the system may be further operated as it is. On the other hand, if such a warning appears in the long run, whereas it was never displayed before, this may indicate for example a strong soiling of the cooling elements and we therefore strongly recommend referring to chapter 11 "Maintenance". This situation may lead to an over temperature error: see case d).

Regulator

4 kW 560 V DC 40% Duty Cycle + 24 V DC

- c) Automatic shutdown initiated by the pilot pins function; the power plug is not connected. If the enable (or ON) signal is present on other Regulators connected together, dangerous voltage may be present at the disconnected cable. For more information on the pilot pins and their function please refer to chapters 4.3, 4.5.2, 7.4, 8.1 and 8.2 and 8.4.
- d) The maximum internal temperature has been exceeded. The warning signal (LED blinking or relay closed) will remain until the internal temperature has decreased to an adequate value. The Regulator will however remain in an error mode until it is reset (see chapter 10.4). Check the compatibility of the continuous power required with the device specifications (chapter 4.1 and 4.2) and the cooling requirements (chapter 7.5).
- e) The Regulator has automatically shut down. See chapter 4.3 "Protection Measures" for some information. Reset the Regulator (see chapter 10.4) and check the conditions of operation. If a fault cannot be attributed to external conditions of operation the device is out of order and needs to be repaired by a specialist. Refer then to chapter 12.
- f) The auxiliary power output 24 V / 5 A DC is available only when the voltage output 1 is above 200V DC. If the output voltage is below 200 V DC, this is likely due to an excessive load requirement with regard to the maximum available power. In which case the position of the Pickup needs verified and/or the load requirement checked. If the white LED is OFF despite an output voltage superior to 200 V DC, then the auxiliary 24 V DC is out of order.

10.4 Reset

When the interface is used:

If a connection with the interface plug is available, resetting a Regulator after a fault simply requires to disable it (open contact pin1 - 4) then to enable it again (close contact pin1 - 4).

When the interface is not used:

If an enable plug (see chapter 14.3) is used removing it will reset the regulator as well.

When it is not possible to proceed as described above because the interface is not used and the enable plug is not accessible, resetting a Regulator can be done using the pilot pins; disconnecting then reconnecting the pilot pins together will reset the Regulator. Attention: pilot pins are not designed to be used as an ON/OFF switch and it is thus recommended not to open the pilot connection under load.

In all cases:

Maximum number of shutdown or disable procedures: 3 times over 30 seconds. The Regulator will then automatically restart after this delay if enabled (i.e. if pin 1 and 4 are connected together).

Moving Pickups away from the track or turning off and back on the primary track supply will also lead to a reset.

Regulator

4 kW 560 V DC 40% Duty Cycle + 24 V DC

11 Maintenance



WARNING!

There is no specific maintenance required other than checking regularly that a free air flow for cooling is given and that there are no damages visible from the outside. Strong soiling or obstacles on the heatsink that would prevent sufficient cooling conditions should be avoided.

Any repair work is only possible at Conductix-Wampfler. See chapter 12.

12 Repair



WARNING!

If a fault cannot be attributed to external conditions of operation, the device needs to be repaired by a specialist.

Warranty seals are placed on the housing in order to forbid the opening of the lid and therefore preventing accidental soiling or insertion of foreign parts. Breaking a seal will terminate the warranty.

Unless otherwise arranged return parts to your nearest Conductix-Wampfler facility or to Conductix-Wampfler GmbH for repair. Before returning any parts, contact Conductix-Wampfler for specific instructions.

Be sure to include the following information when returning parts to Conductix-Wampfler:

- Product name
- Material number
- Serial number, including software and bootloader versions
- Application/Installation, in case with a brief description
- Wiring schematic of overall system, if at hand
- Fault description
- Circumstances the fault occurred at, especially if any unusual events preceded the fault
- Presumption what could have caused the fault
- Photo, if available

Regulator

4 kW 560 V DC 40% Duty Cycle + 24 V DC

13 Disassembly and Re-use



If it is necessary to exchange a Regulator due to damage or to install it in another place, verify that no damage will occur during disassembly.



For installation in another place observe the described mounting and commissioning instructions. Improper application, installation or operation involve the danger of severe injuries to persons and damage to objects.

All electric work has to be carried out by qualified staff (IEC364 respectively, CENELEC HD 384 or DIN VDE 0100 and IEC 664 or DIN VDE 0110 and national safety rules).

Qualified staff, according to the safety regulations, are persons that are familiar with the installation, assembly, commissioning and operation of the energy supply system and that have the appropriate qualifications.

13.1 Safety Advice for Disassembly and Disposal



1. Disconnect the system from the mains voltage.
2. Make sure the system cannot be powered up again accidentally.
3. After disconnecting the track supply from the supply voltage wait at least 5 minutes for internally stored energy to discharge.



4. Dismount the device.
5. Dispose of components in a specific way → Recycling.

13.2 Recycling

The unit contains components that have to be disposed of in a specific way. If it is not used any longer, it will have to be recycled properly. Dispose of the materials separately in accordance with the current regulations, i.e. separate circuit boards, aluminum heatsink and housing, copper, etc. or hand over the unit to a recycling specialist.

Regulator

4 kW 560 V DC 40% Duty Cycle + 24 V DC

14 Accessories

14.1 Power Input X1

The power input of the Regulator must be connected to a suitable Pickup. The use of an extension cable between the Regulator and the Pickup is generally not allowed.

Both Regulator and Pickup strongly depend on each other. Please refer to both operating manuals together. Limiting conditions for one device limit the operation of the other, i.e. if the ambient temperature around a Regulator is higher than what is allowed in the specifications, the maximum continuous power available will be decreased even if the Pickup itself is sufficiently cooled.



The corresponding Pickup for both Regulator versions described in this documentation must be ordered separately through Conductix-Wampfler, i.e. typically:

Material number: 91112-310-3090986

Only a suitable Pickup can be used on the power input X1.

14.2 Power Output X2



A 5 meter long cable, preassembled with one male connector on one side, can be ordered separately through Conductix-Wampfler under material number:

91212-339-3047669.

Otherwise the following components are needed for the connection to the Regulator. Special tools are then needed for the assembly. See chapter 15.

Description	Quantity needed	Material Number Ilme	Material Number Harting
Hood (thermoplastic)	1	CQ08VK	19 12 008 0429
Cable gland (thermoplastic)	1	CRQ16	19 12 005 5157
Crimp terminal, male insert	1	CQM04/2	09 12 006 3041
Power crimp contact, male 1,5 mm ² 2,5 mm ²	5 (one type only!)	CXMA1.5 CXMA2.5	09 32 000 6104 09 32 000 6105
Control crimp contact, male 1,5 mm ² 2,5 mm ²	2 (one type only!)	CDMA1.5 CDMA1.5	09 15 000 6101 09 15 000 6106

Regulator

4 kW 560 V DC 40% Duty Cycle + 24 V DC

14.3 Interface



A 5 meter long cable, preassembled with one male connector on one side, can be ordered separately through Conductix-Wampfler under material number:
91212-339-3047358



A compact enable plug allowing an automatic start-up of a Regulator is also available for order through Conductix-Wampfler under material number:
91000-400-3089971

Note: this plug does not allow any remote ON/OFF function nor any of the diagnoses possibilities. Refer to the product documentation for more information.

Otherwise you can find in the table below a choice of possible solutions for the connection to the interface:

Description	Material number Phoenix Contact	Material number Binder
5 m shielded cable, preassembled with 1 male connector	1543113	79 3579 3508
5 m unshielded cable, preassembled with 1 male connector	--	79 3479 3508
Male connector, preassembled with wires	1523492	09 3481 700 08
Male connector, with solder terminals only	1542758	--

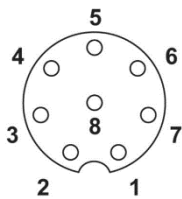

The information below is for reference only. It relies on the 2007 specifications of the manufacturers for the material mentioned in this paragraph only. In case of any doubt, or when using different material than those mentioned above, it will be necessary to check the correspondence between the pin number and the color of each wire in order to avoid possible damage to connected devices.

- PIN 1 > white
- PIN 2 > brown
- PIN 3 > green
- PIN 4 > yellow
- PIN 5 > grey
- PIN 6 > pink
- PIN 7 > blue
- PIN 8 > red or shield

Regulator

4 kW 560 V DC 40% Duty Cycle + 24 V DC

15 Tools

There are no special tools required other than for the assembly and/or disassembly of the separate parts listed in chapter 14.2 for the power connector X2.

Description	Manufacturer	Material number
Crimping tool Han C and HAN D type contacts	Harting	09 99 000 0021
Removal tool for Han C contacts (Power crimp contacts)	Harting	09 99 000 0305
Removal tool for Han D contacts (Control crimp contacts)	Harting	09 99 000 0052

Regulator

4 kW 560 V DC 40% Duty Cycle + 24 V DC

Conductix-Wampfler GmbH
Rheinstraße 27 + 33
79576 Weil am Rhein - Märkt
Germany

Phone: +49 (0) 7621 662-0
Fax: +49 (0) 7621 662-144
info.de@conductix.com
www.conductix.com



Importer for the United Kingdom:
Conductix-Wampfler Ltd.
1, Michigan Avenue
Salford
M50 2GY
United Kingdom

Phone: +44 161 8480161
Fax: +44 161 8737017
info.uk@conductix.com
www.conductix.com